

Yak-52

for DCS World



Pilot's Manual



THE FIGHTER COLLECTION



EAGLE
DYNAMICS



SERIES

Dear pilots!

We thank you for your purchase of the DCS: Yak-52 module. This module is a simulator of one of the most popular training aircraft in the USSR and post-Soviet states.

This module is our first foray into the world of training aircraft; as it is in real life, fledgling pilots will be able to begin their journey to the skies in a craft that is simple and easy to maneuver, while seasoned veterans will have at their disposal an elegant and beautiful aircraft for use in sports and aerobatic performances in the skies of DCS.

Like all the DCS modules that came before it, the Yak-52 is a thoroughly reproduced model of the aircraft: including the exterior, cabins, mechanical/electrical systems, and aerodynamic characteristics.

Pilots and experts of the "Первый полет" (First Flight) flying club were involved in the development of this module, which made it possible to actively use real aircraft, as well as the invaluable experience of people who have worked with the craft, in our work. This has allowed us to create one of the most accurate virtual realizations of the Yak-52 in history.

The Yak-52's two-seat cockpit layout will also allow for online training sessions in the same aircraft between experienced pilots and their apprentices. The module supports all the basic functionality of both cabins, with real differences and locks, both for the trainee pilot and their instructor.

We wish you clear skies ahead.

The DCS: Yak-52 Development Team.

TABLE OF CONTENTS

FOREWORD	12
YAK-52: THE CUTTING EDGE IN TRAINING AVIATION.....	12
AIRCRAFT DESIGN	15
GENERAL INFORMATION	15
AIRFRAME CONSTRUCTION	18
FUSELAGE	18
COCKPIT AND CANOPY.....	19
<i>Canopy Cover</i>	19
<i>Pilot Seating</i>	20
WINGS	20
<i>Wing Framework</i>	20
<i>Ailerons</i>	21
<i>Landing Flaps</i>	21
TAIL	21
<i>Tailfin</i>	21
<i>Rudder</i>	21
<i>Stabilizers</i>	22
<i>Elevators</i>	22
CONTROL SYSTEMS	22
<i>Elevator Control</i>	23
<i>Aileron Control</i>	24
<i>Control Stick and Control Shaft</i>	24
<i>Rudder control</i>	24
<i>Front cabin pedals</i>	25
<i>Rear cabin pedals</i>	26
<i>Elevator trimmer control</i>	26
<i>Landing flap control</i>	26
TAKEOFF AND LANDING GEAR	27

<i>Undercarriage</i>	27
MAIN UNDERCARRIAGE LEG	28
<i>K141/T141 Wheels</i>	28
<i>Undercarriage nose strut</i>	28
AIR SYSTEM.....	28
<i>Main system</i>	30
<i>Emergency system</i>	31
FUEL SYSTEM.....	31
BRIEF DESCRIPTION OF THE AGGREGATES.....	33
<i>Oil system</i>	33
<i>Oil cooler cowling</i>	34
POWERPLANT	35
ENGINE COOLING SYSTEM.....	35
<i>Cowl panel</i>	35
<i>Carburettor air scoop</i>	36
<i>Shutters</i>	36
<i>Exhaust housing</i>	38
<i>Compressor air cooling system</i>	38
<i>Generator air cooling system</i>	38
<i>Engine control and aggregates</i>	38
AIRCRAFT PROPELLER (V-530TA D35)	39
<i>Propeller design and function</i>	39
<i>Mechanism</i>	40
<i>Propeller construction</i>	41
COCKPIT	43
FRONT COCKPIT	43
REAR CABIN	46
FLIGHT CHARACTERISTICS	50
YAK-52 FLIGHT CHARACTERISTICS	50
OPERATIONAL LIMITATIONS.....	50

MASS AND ALIGNMENT	51
M-14P ENGINE SPECIFICATIONS	52
<i>Oil temperature at engine inlet</i>	53
<i>Cylinder head temperature</i>	53
<i>Engine modes of operation</i>	54
<i>Fuel consumption data</i>	54
STARTUP AND TAXIING	56
PRE-ENGINE START-UP CHECKLIST	56
ENGINE START-UP CHECKLIST	69
ENGINE START-UP PROCEDURE	71
ENGINE WARMUP	74
BOOT-UP AND INSPECTION - AGI-1	75
BOOT-UP AND INSPECTION - RADIO STATION	76
INSPECTION - ARK-15M AUTOMATIC DIRECTION FINDER	77
PREPARATION FOR TAXIING	81
PHYSICS OF FLIGHT	84
ON TAKEOFF	84
<i>Rollout</i>	84
<i>Liftoff and acceleration</i>	85
DURING LANDING	86
<i>Flare-out</i>	86
<i>Flare-up</i>	87
<i>Touchdown and landing roll first half</i>	87
<i>Landing roll second half</i>	88
IN A BANKING TURN	88
<i>Conditions of a banking turn</i>	88
DIVE	90
<i>Pull-down</i>	90
<i>Linear segment</i>	90
<i>Dive recovery</i>	91

ZOOM	91
<i>Entry</i>	92
<i>Linear segment</i>	92
<i>Zoom Departure</i>	93
HOOK TURN	93
DURING A VERTICAL (NESTEROV'S) LOOP	94
CIRCULAR FLIGHT	97
TAKEOFF AND CLIMB	98
TURNS ON CROSSWIND AND DOWNWIND LEG	99
<i>Turn on crosswind leg</i>	99
<i>Turn on downwind leg</i>	100
TURN ON BASE LEG FROM DOWNWIND LEG	102
BASE LEG TURN	103
TURN TO FINAL, AND FOLLOW-UP ACTIONS	104
<i>Go-around/Wave-off</i>	106
LANDING	106
<i>Pre-landing checklist</i>	106
<i>Flare-out</i>	106
<i>Flare-up</i>	107
<i>Landing</i>	107
<i>Landing roll</i>	107
<i>Post-landing taxiing</i>	107
<i>Engine shutdown</i>	108
COMMON MISTAKES DURING LANDING	109
OVER-FLARING	109
<i>Causes</i>	109
<i>Corrective measures</i>	110
BALLOONING	110
<i>Causes</i>	110
<i>Corrective measures</i>	110

BOUNCED LANDINGS	111
<i>High-speed bouncing</i>	111
<i>Non-high-speed bouncing</i>	112
AEROBATICS	113
30° - 45° ROLLING CIRCLE	113
<i>Technique</i>	113
60° ROLLING CIRCLE	114
DIVE	115
<i>Pull-down</i>	115
<i>Dive rollout</i>	115
ZOOM	116
HOOK TURN	118
SPLIT S	119
AILERON ROLL	120
VERTICAL LOOP (NESTEROV'S LOOP).....	121
IMMELMANN	122
SPIRAL DESCENT.....	124
<i>Exiting the spiral</i>	125
GLIDING DESCENT	125
CLIMB	126
LEVEL FLIGHT.....	127
DESCENT.....	128
TAILSPIN	129
INVERTED SPIN.....	130
FLAT SPIN	131
PARACHUTE DESCENT.....	131
CONTROLLED UPWARD SPIN	132
HORIZONTAL STALL TURN	132
FLYING SKILL ERRORS	133
HORIZONTAL MANEUVER ERRORS	133

VERTICAL MANEUVER ERRORS	135
CHARACTERISTIC ERRORS WHEN PERFORMING A GLIDING DESCENT.....	137
CHARACTERISTIC ERRORS WHEN PERFORMING A SPIN.....	138
<i>Stalling from bank into spiral spin</i>	140
<i>Stall from turn during climb</i>	140
<i>Stall from turn during gliding</i>	140
INSTRUMENT FLYING	142
ILLUSORY SENSATIONS DURING INSTRUMENT FLIGHT	142
LEVEL FLIGHT MODE	142
CLIMBING	143
GLIDING	144
TURNS ON THE HORIZONTAL PLANE WITH ROLLOUT TO SET COURSE	145
TURNING TO CLIMB AND GLIDE	146
<i>Turning to climb</i>	146
<i>Turning to glide</i>	147
GUIDELINES FOR INSTRUMENT FLIGHT WITH A DISABLED ARTIFICIAL HORIZON	148
EMERGENCY PROCEDURES.....	152
ENGINE TROUBLE	152
<i>Engine failure in flight</i>	152
<i>Fuel pressure drop</i>	152
<i>Engine shaking</i>	153
<i>Propeller overspeeding</i>	153
IN-FLIGHT FIRE	153
EMERGENCY LANDING WITH A DEAD ENGINE.....	154
PARACHUTE JUMP	156
ARK-15M RADIOCOMPASS FAILURE	157
GENERATOR FAILURE	157
AIRSPEED INDICATOR FAILURE	158
ALTIMETER FAILURE.....	159
VERTICAL RATE INDICATOR FAILURE.....	159

DS-1 FAILURE SENSOR HEATING FAILURE	159
EMERGENCY UNDERCARRIAGE DEPLOYMENT	159
FORMATION FLYING DRILLS.....	162
SINGLE-FILE TAKEOFF	162
PAIR TAKEOFF	162
JOINING FORMATION	163
STRAIGHT-LINE FORMATION FLIGHT AND CLIMB	164
<i>Climbing while in formation</i>	164
AEROBATIC MANEUVERS WHILE IN FORMATION.....	165
<i>Diving and zooming while in formation</i>	165
<i>Entry into banking</i>	166
<i>Banking execution</i>	166
<i>Rollout from banking</i>	167
<i>Turning while in formation</i>	167
<i>Changing formation</i>	167
<i>Gliding while in formation</i>	168
<i>Retracting the undercarriage while in formation</i>	168
<i>Deploying the undercarriage while in formation</i>	168
<i>Pre-landing formation breakup</i>	169
<i>Pair landing</i>	169
TYPICAL DEVIATIONS IN FORMATION FLIGHT.....	169
<i>Typical errors during pair takeoff</i>	170
<i>Typical errors when joining formation</i>	171
<i>Typical errors during formation change</i>	171
<i>Typical errors during formation diving</i>	171
<i>Typical errors during formation zoom</i>	171
<i>Typical errors during pair landing</i>	171
<i>Pilot actions after losing visual of the lead craft</i>	172
RADIO COMMUNICATIONS.....	174
<i>Simplified Radio Communication</i>	175

<i>Realistic Radio Communication</i>	176
RADIOCOMMUNICATIONS MENU	176
F1 WINGMAN	176
<i>F1 Navigation</i>	177
<i>F4 Maneuver</i>	177
<i>F5 Rejoin Formation</i>	177
F2 FLIGHT.....	178
<i>F1 Navigation</i>	178
<i>F4 Maneuvers</i>	178
<i>F5 Formation</i>	179
<i>F6 Rejoin Formation</i>	184
F3 SECOND ELEMENT.....	184
<i>F1 Navigation</i>	185
<i>F4 Maneuvers</i>	185
<i>F5 Rejoin Formation</i>	185
FLIGHT MEMBER RESPONSES.....	186
F5 AIR TRAFFIC CONTROLLER (ATC).....	186
F8 GROUND CREWS	187
ADDENDUM	189
CAUCASUS AIRFIELD DATA, WITH SHORAN	189
CAUCASUS AIRFIELD DATA	190
NEVADA AIRFIELD DATA	191
EAGLE DYNAMICS.....	192
<i>Executive Board</i>	192
<i>Programmers</i>	192
<i>Designers</i>	192
<i>Sound</i>	192
<i>Quality Control</i>	193
<i>Localization</i>	193
<i>IT and Customer Support</i>	193

INTRODUCTION



FOREWORD

Yak-52: The Cutting Edge in Training Aviation

What makes an aircraft suitable for the delicate task of training aspiring pilots in the art of flight? Lightness, ease of use, manoeuvrability, and safety. These were the traits that would eventually become the versatile Yak-52.

The brainchild of the engineers and designers of the A.S. Yakovlev Experimental Design Bureau, the Yak-52 is a single-engine double-seat trainer monoplane with a low-mounted wing. Among the main tasks of the Yak-52 are training pilots of different skill levels, as well as training in instrument flight and glider towing. Owing to its powerful engine, the aircraft is capable of performing both simple and complex aerobatic maneuvers, while its navigation and radio-electronic systems allow the pilot to navigate in conditions of reduced visibility (i.e. in the clouds). The aircraft's performance is also unhindered by frost, as the cockpit is equipped with heating and ventilation systems, and the aircraft's units are capable of operating at temperatures down to -45°C .

The designers came up with several innovations: an undercarriage with nose-mounted landing gear, and a fuel system that allowed for inverted flight and maneuvers with negative G-loads.

The Yak-52 became one of the main workhorses not only of domestic training aviation in Russia, but of Russian and international aerobatics competitions and championships as well.

The aircraft first took to the skies in 1976. During its creation, the designers took elements from the Yak-50 and Yak-18 models, but made some improvements. The Yak-50 and Yak-52 had to be very similar to each other (for cross-compatibility of the parts and structural elements) yet at the same time fly in completely different ways. For an aircraft designed for sports and aerobatics, minimal stability and quick response to the pilot's slightest action are key, yet an aircraft built for training purposes must be stable, much less sensitive to pilot input, and capable of carrying a fairly weighty equipment package onboard.

The Experimental Design Bureau was faced with the task of designing an aircraft that was both sufficiently stable and maneuverable (capable of performing even spinning aerobatic figures) - and their efforts were met with success. The designers finished their work in record time, with the entire design process taking only a few months. It is noteworthy that the project was led by a team of experienced designers, with V.P. Kondratiev at its head, and that the collaboration of the bureau's divisions was coordinated by members of the Komsomol.

After only six months, the Yak-52's first prototype went into flight testing. The aircraft's systems were all made to very high standards; scientists and pilots very thoroughly studied the aircraft's characteristics during spin recovery, takeoff, landing, and flight with maximum speed and G-force loads.

The two-year tests were conducted successfully, and the experts' recommendations were taken into consideration when the aircraft was launched into mass production, which was carried out from 1979 to 1995 at the Aerostar aircraft plant in Romania. Thanks to the results observed during flight testing, the serial models of the Yak-52 did not require any further modifications or fine-tuning, and very quickly occupied its intended niche.

Several modifications of the Yak-52 have been released into the air since the time of its inception. The export version of the Yak-52, designated the Yak-52W and modified for American and European customers, is outfitted with equipment for flight in low-light conditions, a baggage compartment in the fuselage, as well as hydraulic brakes and larger-sized fuel tanks.

A single-seat variant was created in 1981 specifically for the execution of complex air maneuvers. This variant was based off of a serial production aircraft, the Yak-53.

The military version of the aircraft, the Yak 54 (Yak 52B), was created in 1983 and received a reinforced wing. For combat deployments in Afghanistan, the designers attempted to modify the aircraft into a light attack platform equipped with two pods of unguided rockets. However, the aircraft was deemed too lightweight for both cannon and rocket weapons. It never went into mass production, and work was halted in the same year.

In 1991, Romanian specialists modified the Yak-52, installing new engines, a three-blade propeller, and an improved rudder. The new variant was dubbed the "Condor".

Another version of the training aircraft was the Yak-52TW, equipped with a tail wheel.

The modernized variant, the Yak-52M, was the result of work carried out in the 21st century. The designers replaced the original design's engines with a more powerful model, increased the aircraft's fuel reserve to 250 liters, improved the canopy, the wing, the internal equipment and the ejection system. The aircraft was presented to the public at the MAKS-2003 International Aerospace Show, and the modernized aircraft's maiden flight took place in 2004. Yak-52s manufactured before 2003 are continuously being retrofitted to the standard of the Yak-52M.

More than 1800 Yak-52 aircraft have been produced over the forty-odd years since its inception. Around 100 units still see use in Russia, while some units are used in the territory of the former Soviet republics.

Having seen numerous modifications, the training aircraft has become, and still remains, an indispensable element of the initial training of flight operations personnel and of pilots in civil aviation schools.

2016 saw the maiden flight of the Soviet machine's successor - the Yak-152.

AIRCRAFT CONSTRUCTION



AIRCRAFT DESIGN

General Information

The Yak-52 is a two-seat training aircraft designed for basic pilot training. The aircraft has an M-14P 360 horsepower air-cooled engine equipped with a V530TA-D35 propeller. The aircraft is also equipped with a radio station, an intercom, navigation and flight equipment, landing flaps, and a retractable undercarriage with brake wheels; these allow trainee pilots to acquire the necessary skills in the usage of standard equipment present in most modern aircraft.

The high power-to-weight ratio and good maneuverability allow for the training of pilots in performing simple and complex aerobatic figures. The simplicity of the aircraft's construction, combined with its high durability and reliability make for very safe flights.

Main characteristics:

• Aircraft empty weight	1035 kg
• Maximum takeoff weight	1315 kg
• Aircraft length	7676 mm
• Aircraft height	2700 mm
• Wingspan	9500 mm
• Wing surface area	15 m ²

Aircraft flight data

• All out level speed With a weight of 1315 kg, flying at an altitude of H = 1000 m	270 km/h
• Operational ceiling	4000 m
• Time-to-climb H = 4000 m at the I rated power setting	15 min'
• Practical range At an altitude of H = 500 m, with a takeoff weight of 1315 kg (with max fuel load), and at cruising airspeed of IAS = 190 km/h (with a 10% emergency fuel reserve)	500 km
• Maximum load factors	-5, +7
• Maximum allowable speed for flight control	360 km/h
• Concrete runway liftoff distance with a takeoff weight of 1315 kg and a takeoff speed of 120 km/h	180 - 200 m
• Concrete runway rolling distance With a landing weight of 1315 kg, contact velocity of 120 km/h, and with landing flaps deployed	260 m
• Maximum permissible speed of the crosswind component at an angle of 90° to the runway during takeoff and landing of the aircraft	6 m/s

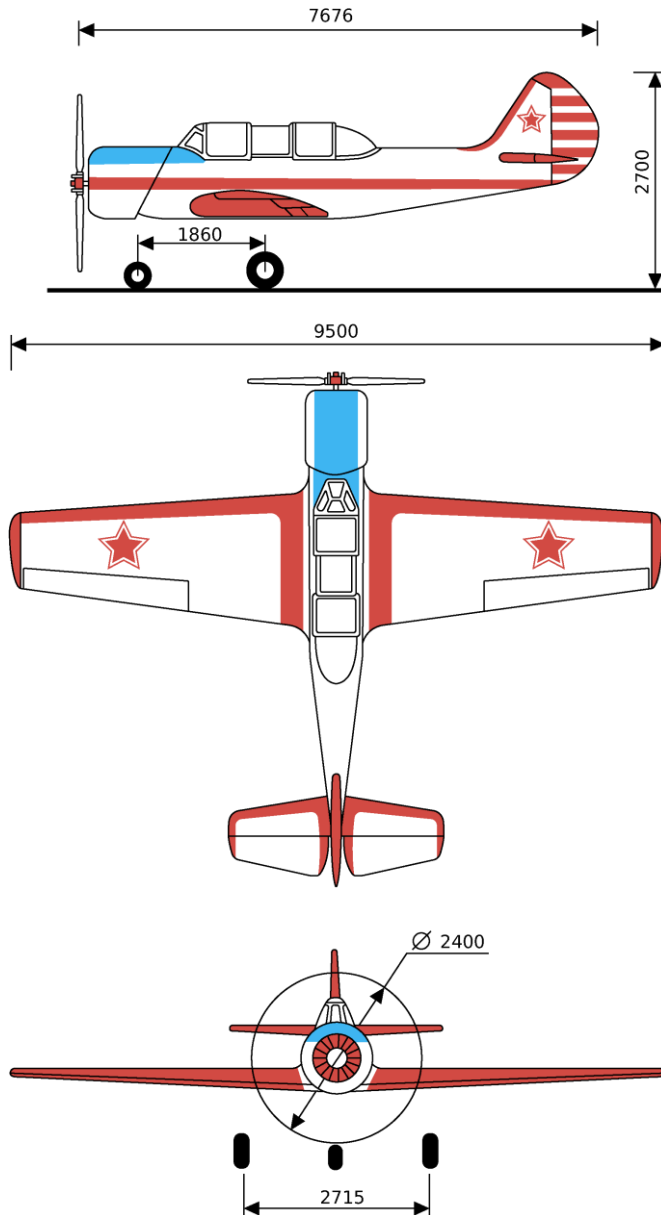

Figure 1. Yak-52 aircraft dimensions.

Engine characteristics

• Engine identification code	M-14P
• Cooling system	Air cooled
• Cylinder number and positioning	Single-row radial
• Cylinder numbering order (counter-clockwise)	Upper cylinder - No 1
• Compression ratio	6.3 +0.1
• Propeller shaft rotation direction	Left, in flight direction
• Propeller	V 530 TA-D35
• Engine critical altitude	Sea-level engine/low-altitude
• Engine ground power	360 - 2 hp.
• Crankshaft revolutions per minute	2900+ 1%

Continuous engine running time:

- Takeoff mode	No more than 5 min
- In never-exceed speed	No more than 1 min
- All other modes	Indefinite
• Transition time (acceleration) from idle (700 rpm) to takeoff on a stationary aircraft:	No more than 3 seconds
• Engine startup system	Air
• Fuel grade	B-91/115 aviation gasoline with an octane grade of no less than 91
• Oil grade	MS-20
• Oil pressure at engine inlet:	4-6 kg/cm ²
• Minimum allowable oil pressure	1 kg/cm ²

Fuel pressure in front of the carburettor:

• Under normal operating conditions	0.2 - 0.5 kg/cm ²
• During idle throttle, no less than	0.1 kg/cm ²

Oil temperature at engine inlet:

• Minimum permissible temperature	40°C
• Recommended	50 - 65°C
• Maximum on prolonged engine operation	75°C
• Maximum permissible for no longer than 15 minutes of continuous engine operation	85°C

Cylinder head temperature:

• Recommended:	140°-190°C
• Minimum allowable for normal engine operation:	120°C
• Maximum on prolonged engine operation:	220°C
• Maximum allowable on takeoff and climb modes for no longer than 15 min. and no more than 5% from engine lifespan	240°C

AIRFRAME CONSTRUCTION

Fuselage

The fuselage of the Yak-52 is of an all-metal semi-monocoque design with a load-bearing skin. The transverse frame of the fuselage substructure consists of nineteen frames and an additional 0 frame, which both serves as a fireproof bulkhead and carries the engine mounts. This frame is a blind duralumin wall which is edged along the contour and reinforced in the node installation locations by means of profiles. The engine frame attachment points, the mounting brackets of the nose undercarriage leg and the nose panel, as well as the oil storage tank lugs are all installed on the front wall of the 0 frame.

The niche for the nose-mounted undercarriage leg is located in the lower part of the fuselage, between frames 0 and 2. The floor of the frontal cockpit is located between frames 0 and 3, while the floor of the rear cockpit is in between frames 5 and 8. The floors are made of duralumin sheets reinforced with longitudinal profiles. Cutouts are made where the aircraft control levers are mounted; after the control levers have been installed, these cutouts are then covered in a protective hood. Attachment of the wings to the fuselage is carried out along frames 3, 5 and 8. For this purpose, the front and rear of the butt joints are installed on frames 3 and 8. The frames where the wings are installed are supported by fittings and transverse walls.

The pilots' seats are fixed to the cabin, with the frontal seat attached to frames 4 and 6, and the rear seat to frames 9 and 10. The rear fins are attached to the tail part of the fuselage: the vertical fin is fixed along frames 16 and 19, while the horizontal fin is located along frames 16 and 18.

The skin of the frontal section of the fuselage, up until frame number 12, consists of seven duralumin panels with a thickness of 1.0 mm.

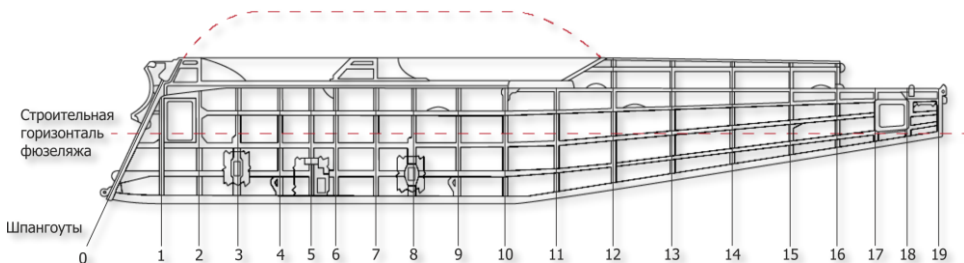

Figure 2. Yak-52 fuselage skeleton.

The skin of the tail section of the fuselage, located between frames 12 and 19, consists of four panels and an upper lining. The top panel is fixed to the substructure between frames 11 and 16 and has a thickness of 0.8 mm.

Two 0.6 mm side panels are attached to the substructure between frames 12 and 15. Another panel with a thickness of 1.5mm and located on the tail section, fixed between frames 15 and 19, is chemically

milled to thicknesses of 1.2, 1.0 and 0 mm. The upper lining between frames 16 and 19 has a thickness of 2 mm. All these panels are attached to the substructure by means of rivets.

Cockpit and Canopy

Canopy Cover

The cockpit canopy consists of a windshield, and two sliding middle and tail parts that are located between frames 0 and 12.

The sliding part moves along six bearings mounted on two guide rails fixed to the left and right side of the aircraft fuselage. The bearings are attached to the side frames by means of clamping shoulders and slave bolts with locknuts.

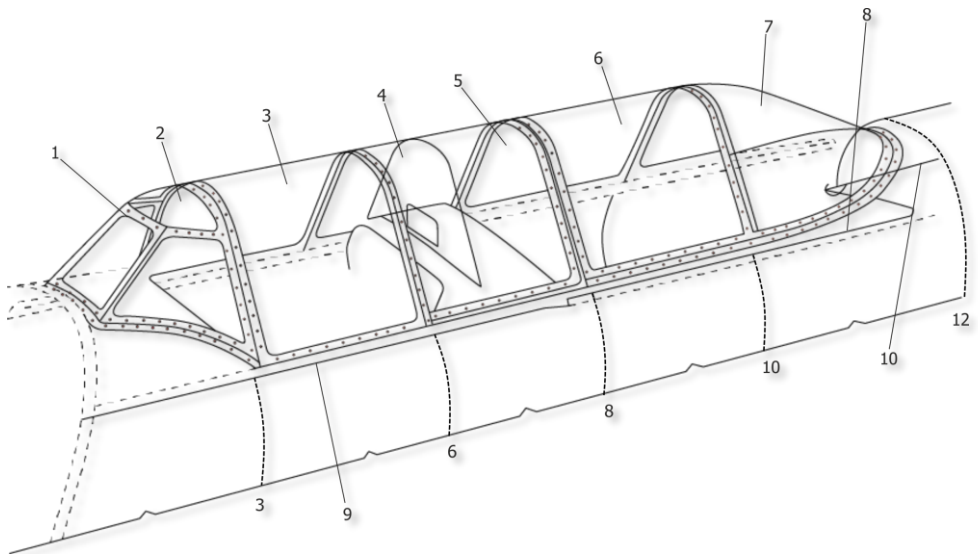

Figure 3. Canopy.

1 – Windshield 2 – Windscreen; 3 – Moveable part of the first cockpit; 4 – Partition wall; 5 – Cockpit canopy central part; 6 – Moveable part of the second cockpit; 7 – Canopy rear section; 8 – Slide-rails; 9, 10 – Shock-absorbers.

When in the closed position, each of the canopy's sliding parts is fixed in place with a lock. The lock consists of the lock body, a pin, a lever, a spring, and a leash attached to the pin by means of a nut. The leash is connected to a pull rope that passes through the tubing of the chassis and leads to a ball.

The lock lever is pivotally attached to the frame bracket and slides into the groove of the spring-loaded pin. It has a second arm that exits through the slot in the edging of the sliding part from the outside. When the canopy is in the closed position, the pin enters the socket located on the fuselage. To open the canopy from the ground, simply press the second lever arm of the lock (i.e. the one which faces outwards.) To open the lock from within the cockpit, the pilots must simply pull the ball located over their head in order to raise the lever and remove the pin from its socket.

Pilot Seating

The pilots' seats are installed on frames 4 and 6 in the first cabin, and on frames 9 and 10 in the second cabin. The seats are fixed in height. The frame of each chair consists of a duralumin cup and backrest, riveted together and with two longitudinal profiles of a П-shaped cross-section. The brackets used for attaching the chair to the fuselage are riveted to the backrest and cup.

Each chair is equipped with a safety harness system consisting of belts for the shoulder, waist and central torso. The right and left waist belts are attached to the cup of the chair, while the shoulder straps are attached to brackets on frames 10 and 6; the central torso strap in the first pilot's cockpit is fixed to the bracket on frame 3, while in the second cockpit it is fixed to the ear of the rear control shaft bearing located on frame 8.

Wings

The wing of the aircraft is made according to a monospar wing scheme complete with a load-bearing skin and consists of outerwing panels. Each of them is equipped with an aileron and a landing flap. The outerwing panel joins with the fuselage by means of three butt joints. The joints of each outerwing panel are located on the leading wall, the wing spar, and the rear wall, while the fuselage's corresponding butt brackets are located on frames 3, 5 and 8.

The main undercarriage legs are mounted on the root portions of the outerwing panels, in between ribs 4 and 5. Fuel tanks are located in the outerwing panels between the front wall, the wing spar, and ribs 1-4. The access hatches of the fuel tank filler ports are located on the top cover of the wing panels around rib 2. A slot for the locking pin of the T3 refuelling nozzle is installed on the edging of the access hatches, right under the covers.

Hooks for mounting the detachable pilot footrests are mounted on the lower side of the aircraft skin on the left side wing panel, right behind the landing flaps between ribs 1 and 2.

Wing Framework

The wingframe panel constitutes of longitudinal and transverse sets. The longitudinal set consists of a spar, front and rear walls, an aileron wall, a wall that defines the cutout area under the flap, and a set of stringers; The transverse set consists of 15 ribs. The longeron of the wing panel is a duralumin rivet beam of a variable cross-section, consisting of a wall supported by an angle iron and two booms. The

root section of the spar has bolts which are equipped with the docking joints that connect the wing panels to the fuselage. The front wall is located between ribs 1 and 6 and is a riveted beam consisting of a wall and two squeezed shaped section bars. The rear wall is a sheet of duralumin riveted to the stringers of the longitudinal set and located between ribs 1-7. The ribs of the outerwing panels are split, are made of duralumin, and consist of the bow and tail parts. The airspeed boom mounting bracket is installed on the left-wing panel on the nose of rib 13, while the mounting bracket for the DS-1 sensor of the SSKUA-1 system is installed between the ribs 10 and 11. Between the ribs 1 and 3 in the right-wing panel and just behind the longeron is the 2281-B air-oil cooler. The oil-cooler air duct and airflow regulation doors are located on a common panel, which is fastened with screws with anchor nuts to the lower wing surface along the longeron, ribs 1 and 3, and stringer 6.

Ailerons

The aircraft's wings feature slot-lip ailerons equipped with axial compensation. The frame of the aileron consists of a tubular duralumin longeron, nine ribs, and a tail stringer. The ribs are attached to the longeron by means of iron-angles. The aileron sock is covered with a duralumin sheet, and the entire aileron is covered with a linen plating.

Landing Flaps

Shrenk-type landing flaps are installed on the the aircraft's wing panels, and each flap is a duralumin riveted structure consisting of a channel sidemember and seven stamped ribs. The flaps are attached to the wing panels by means of a hinge strap composed of duralumin ramps and steel ramrods.

Tail

The aircraft's trapezoid-shaped tail fins consist of two horizontal and one vertical fin. The vertical tail fin includes a keel and a rudder equipped with an aerodynamic compensator. The horizontal tail fins consist of two integral stabilizer arms and two halves of the elevator. The left half of the rudder is equipped with a trimmer.

Tailfin

The structural frame of the tailfin is formed by the front and rear side longerons, in addition to a set of ribs. The longeron of the tail is of a channel section construction. On the rear side longeron of the tail, there are two hinge fittings for the rudder, while the third fitting is mounted on frame 19 of the fuselage. There is a fuselage spine fairing made of fiberglass sheet that is fixed to the tail and fuselage skin by means of bolts and rivets.

Rudder

The rudder frame consists of a tubular duralumin spar, five ribs and a contour. A cowl made of sheet duralumin is riveted to the ribs' socks, while three hinge points are installed on the spar itself. The upper and middle points are aluminum brackets, stamped from AK6 aluminum alloy, with steel studs

pressed into them. These brackets are riveted to the spar and toe ribs. The lower hinge is also stamped from the AK6 aluminum alloy, and is made in conjunction with a two-arm lever for rudder control. The bracket is threaded onto and riveted to the longeron through a special hole.

Stabilizers

The stabilizer frame consists of a front and rear longeron, ribs, and stringers. The front side channel section longeron consists of two parts. The left and right parts are connected along the centre line by means of a splice joint. The brackets of the frontal stabilizer junction (connecting it to the fuselage) are mounted on the bolts on the wall of the front longeron located by rib 1. The rear spar is of a continuous channel section and consists of a spar web and two booms. Two brackets, connecting the stabilizers to the fuselage, as well as the hinge fitting for the elevators, are attached to the longeron located between ribs 1.

Elevators

The elevator is split and is made of two halves. The frame of each half consists of a tubular spar, a rear rim, and five ribs. The frontal part of the elevator is a box-like structure formed by a nylon duralumin rib sheathing and a reinforcing wall located in front of the spar. The tip of the elevator is made of AMG2M sheet material 0.8 mm in thickness and is riveted to rib 5. The side hinge points of the elevator are brackets with pins. The middle hinge assembly is used to connect the left and right halves of the rudder; this hinge assembly is composed of a sector to which the flanges of the right and left halves of the rudder, the lever with the balancing weight, and the cable wire of the elevator control are all fixed. A ball bearing is pressed into the central part of the sector; this bearing is connected to the central hinge assembly of the rudder on the stabilizer. Hinge assemblies are mounted at the spars near ribs 3 and 5 of each half of the rudder; these are stamped from AK6 aluminum alloy and have steel pins pressed into them. Brackets are attached to the spar and walls of the ribs. The elevator is covered with linen. The left half of the rudder is equipped with a trimmer, which is located between ribs 1 and 3, and is attached to the frame of the rudder on a piano-wire loop. The trimmer is made of foam and glued on all sides with fiberglass. A bracket is attached to the underside of the trimmer; the control rod of the trimmer is connected to this bracket.

Control Systems

The aircraft is controlled by means of a hand-operated control stick and foot-operated pedals located in both the first and second cabins. The stick and pedal control systems are independent of each other in order to provide precision pitch, roll, and yaw control of the aircraft. The control stick commands the aircraft's elevators and ailerons, while the pedals control the rudder. A trimmer is installed on the left half of the aircraft's elevator and is designed to minimize pilot micromanagement of the aircraft's elevators while in flight.

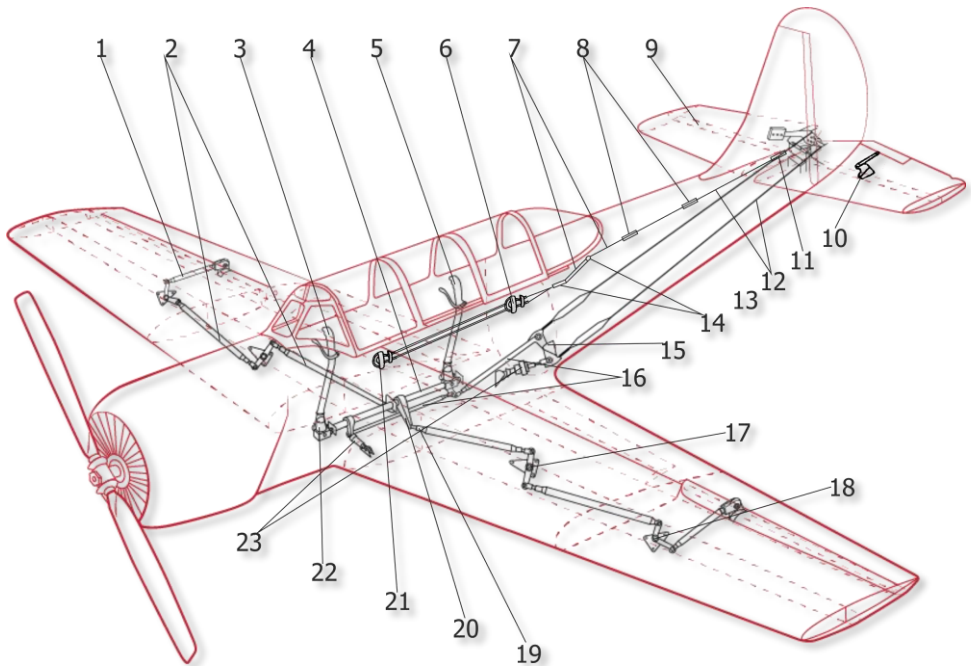

Figure 4. Control system for the elevators, ailerons, and elevator trimmers

1, 2 - push-pull rod; 3 - front cabin control stick; 4 - control shaft; 5 - rear cabin control stick; 6 - elevator trimmer control handle installation in the second cabin; 7 - cable wiring; 8 - turnbuckles; 9 - elevator sector with counterweight; 10 - control system of the elevator trimmer; 11 - bracket with roller on the frame; 12 - cable wiring; 13 - guide rollers; 14 - turnbuckles; 15 - sector installation on frame 10; 16 - push-pull rod; 17 - bellcrank installation at the rib; 18 - bellcrank installation at the rib 8; 19 - aileron bellcrank; 20 - mounting bracket with supports; 21 - elevator trimmer control handle installation in the first cabin; 22 - body with supports; 23 - loading mechanism.

Elevator Control

The elevator is controlled by means of a control stick installed in the first and second cabs on the control shaft. When the handles are completely pushed or pulled from the neutral position by an angle of $\pm 16^\circ$, the elevator is deflected by $\pm 25^\circ$. The maximum angle of deflection of the elevator is limited by mechanical stops installed in the front housing of the control shaft. The elevator controls are of a mixed type: it is rigid between frames 2 and 10 and cable-operated behind frame 10. The control sticks of the first and second cabins are rigidly connected to each other by a tubular titanium or steel rod. When the control stick is manipulated in the first cabin, this movement is transferred through the duralumin tubular rod, connected to the pivot of the control stick in the second cabin, onto the quadrant

installed on frame 10. There is a feel spring mechanism on frame 9 for the pilot pitch controls; this mechanism is pivotally connected to the quadrant installed on frame 10. The elevator quadrant and the quadrant on frame 10 are interconnected by a cable harness, the ends of which are embedded on a ball.

Aileron Control

The ailerons are manipulated by means of the control knobs installed in the first and second cabins, and by the wiring connecting the control shaft walking beams to the ailerons. The wiring to each aileron is rigid, consisting of tubular rods and walking beams. If one of the control sticks is turned to the right or left by an angle of 14° , the ailerons deflect upwards by 22° and downwards by 16° . If one of the control knobs is deflected, the walking beam that is fixed to the control shaft rotates; the force from this is transmitted through the walking beam and push-pull rod to the output aileron walking beam. The maximum angles of deflection of the ailerons are limited by the mechanical restraints mounted on the fuselage beam.

Control Stick and Control Shaft

The control stick in the first cabin is installed right in front of frame 3, while in the second cabin it is installed in front of frame 8. The sticks are fixed on the control shaft located under the floor between frames 2 and 8. The control shaft consists of the front and rear shafts both of which are connected by two conical bolts.

The maximum pitch deflection of the control sticks are limited by adjustable mechanical restraints which are installed in the mount housing assembly of the front cabin stick. The rolling deflection of the control sticks (and thus of the ailerons) are limited by adjustable stops mounted on the fuselage beam. Mechanical restraints are fixed in the bracket, which itself is fixed to the bottom flange by means of bolts. A spring mechanism is fixed in between frames 3 and 4 for transmitting the pilot's stick input into aileron movement. The mechanism is connected to the control shaft through the walking beam. Each control stick is a curved tube with a rubber handle mounted on the top; a pivot pin at the bottom is used to attach the handle to the control shaft and push-pull rods. The kingpin of the rear control stick is connected by a push-pull rod with a control sector mounted on frame 10. A bracket is installed on the upper part of the control stick, right under the grip. A brake handle equipped with a cable harness to manipulate the U-139 (PU-7) pressure reducing valve of the undercarriage wheel braking system is mounted on this bracket. At the top of the rubber handle of the control stick of the rear cabin is a brake release button for the wheels of the main undercarriage legs. The parking brake function is realized by locking the brake lever of lever 14, which are located on the pilot control stick in both the front and rear cabins.

Rudder control

Control of the rudders is done by means of the rudder pedals (installed in both the first and second cabins) and the cable wiring connecting the pedal sectors both to each other and to the rudder bracket. The full range of the pedals corresponds to the rudder deflection of an angle of $\pm 27^\circ$.

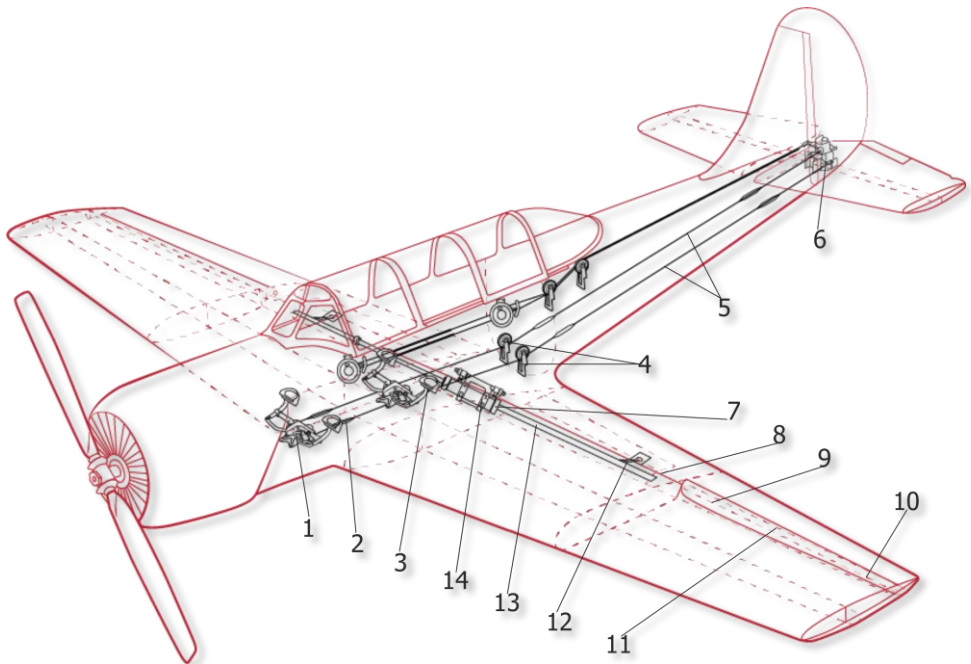

Figure 5. **Control system for the rudders and landing flaps.**

1 - front cabin pedal installation; 2 - turnbuckle; 3 - rear cabin pedal installation; 4 - bracket with roller on the frame; 5 - cable wiring; 6 - rudder-support horn; 7 - microswitch for signaling the retracted position of the flaps; 8 - rod; 9 - turnbuckle; 10 - flap; 11 - support; 12 - microswitch for signaling the released position of the flaps; 13 - push-pull rod; 14 - installation of the cylinder on frame 8.

Front cabin pedals

Pedals are installed on the floor around frame 1 in the front cabin. The rudder pedals are of a parallelogram type and are adjustable to pilot height with a range of 100 mm. They are mounted on a plate bolted to the floor of the cabin. A centreline is fixed on two bearings on the plate; the sector and the adjustment mechanism for the pedals are fixed together on this centreline. The sector is equipped with mechanical restraints that limit the deflection of the pedals.

The pedal footrest is a bracket with a fluted surface. Straps are fastened to the side walls of the bracket; these serve to secure the pilot's feet on the footrest. Mounting lugs are present on the footrest to secure it to the tubing.

Rear cabin pedals

Pedals are installed on the floor around frame 1 in the front cabin. The rudder pedals are of a parallelogram type and are adjustable to pilot height with a range of 100 mm. They are mounted on a plate bolted to the floor of the cabin. The construction of the rudder pedals in the rear cabin is mostly identical to that of the first cabin's, except for the sector that has two grooves under the cables. A cable connecting the front cabin's rudder pedals passes through the lower groove, while cables leading from the rear cabin's rudder pedals pass through the upper groove into the aircraft's rudder. This connection between the pedals and the differential valve is provided by means of the rods and a pin fixed to the bottom of sector 5.

Elevator trimmer control

Control of the elevator trimmer is mechanical and is carried out by means of a hand wheel installed in the first and second cabins. The wiring consists of the trimmer control mechanism, cables connecting the hub of the hand wheels with the mechanism roller, plus walking beams and tubular rods leading from the mechanism to the trimmer.

The trimmer hand wheels are installed on the left side of the fuselage: in the front cabin it is located between frames 3 and 4, while in the rear cabin it is located between frames 8 and 9. Cables are fixed to the front and rear hand wheels; these connect the hand wheels to each other, and, through the guide rollers installed at frames 10 and 11, lead to the guide rollers located on the rear side longeron of the stabilizer.

The trimmer deflects by an angle of 12° . Mechanical restraints are in place to prevent extreme deflection angles of the trimmer, and these are attached to the roller bracket. When the roller rotates, the worm screw moves to both sides until it meets the mechanical restraints. Position indicators for the elevator trimmer are installed on the hand wheels in both the first and second cabins.

Landing flap control

The control mechanism for the landing flaps includes the following components: an air cylinder, traction rods, pushrods that move in the guide supports, and push-pull rods connecting the flaps to the rods. A 625300M flap deployment/retraction mechanism is present on the left-side control panel in both the front and rear cabins of the aircraft.

The deployed and retracted states of the flaps are signaled by the AM 800K limit switches, mounted on rib 1 of the left wing panel. The landing flaps in their released position deflect at 45° and are held in position by the air pressure in the cylinder and the kinematic lock. In the retracted position, the flaps are held in place by the ball lock of the cylinder.

Takeoff and Landing Gear

Undercarriage

The airplane's undercarriage is of a three-point construction with a nose wheel and is retracted in flight. The system is equipped with a liquid-gas shock absorption system and consists of the nose strut with a 400X150 wheel and the two main struts with 500X150 brake wheels. The nose strut of the undercarriage is installed in the bow of the fuselage and is retracted back in flight under the fuselage. The main legs of the undercarriage are installed in the wingpoints between ribs 4 and 5 and are retracted forward in flight under the wing. In the retracted position, the legs of the undercarriage are held in place by locks. The lock of the retracted position of each main leg is attached to the lower bow of the wingpoint while the locks of the front legs are located in the undercarriage slots. The undercarriage locks in the wingpoints are covered with a cowling.

When in the deployed position, the undercarriage is secured by folding struts, which become inverted from the spontaneous folding of the struts and are protected by a ball lock in the undercarriage lifts. Deployment and retraction of the undercarriage is carried out by lifts operated by the air system.

Table 1. **Undercarriage specifications**

	Nose strut	Main struts
Operating gas in the shock absorption system	liquid-gas technical nitrogen, I grade, GOST-9293-59	liquid-gas technical nitrogen, I grade, GOST-9293-59
Initial pressure of nitrogen in the shock absorbers, kg/cm², operating gas	26+1, AMG-10 oil, GOST 6794-53	19+1 AMG-10 oil, GOST 6794-53
Maximum operating rod stroke of the shock absorption system, mm	150+1	240+1
Air pressure in the pneumatic wheels, kg/cm²	3+0.5	3+0.5

The undercarriage struts are controlled by means of mechanical indicators and an electric alarm system consisting of the annunciator panel, AM-800 micro switches, and the corresponding wiring. The annunciator panel monitoring the undercarriage status is located on the instrument dashboard in both cabins. The limit switches of the undercarriage retracted position are installed on the locks of the retracted position, while the limit switches of the undercarriage released position are located on the links of the breaker struts.

Main Undercarriage Leg

The main undercarriage leg is equipped with a single-sided support of the brake wheel and consists of a telescopic shock absorber, the wheel, a breaker strut, a lifter, a retracted position lock and a mechanical position indicator.

K141/T141 Wheels

The main legs are fitted with K141 / T141 brake wheels equipped with pneumatic expander tube brakes. The wheels have 500 X 150 model 6 half-ball type aircraft tires. The control over the wheel brakes is provided in both cabins by the lever on the control stick connected to the pressure reducing valve and the control pedals connected to the compensation gear. The compressed air, reduced in the valve to a pressure of $8 + 1 \text{ kg/cm}^2$ enters the brake chambers through the compensation gear. The rubber brake chambers expand and press the friction pads against the wheel, creating the necessary braking torque. After depressurization, the brake pads are squeezed off from the rear of the wheel by the return springs.

Undercarriage nose strut

The front leg of the undercarriage consists of the telescopic shock absorber, the wheel, the folding strut, the lifter, the retracted position lock and the mechanical position indicator. The shock absorber consists of the shock absorber tower, the internal set, the mechanism for setting the wheel to the neutral position, the rod with the wheel attachment fitting and the self-excited oscillations dampener. The wheel of the front leg has the ability to turn in both directions at an angle of $50^\circ - 20^\circ$. A mechanism is mounted in tower; this mechanism places the wheel in a neutral position after removing external loads from the wheel.

The front leg has a half-ball type non-braked 44-1, model 5, 400X XI 50 aircraft tire. The deployment and retraction system of the undercarriage and the mechanical position indicators are identical.

Air System

The air system of the aircraft facilitates engine startup, undercarriage deployment and retraction, landing flap control, and the undercarriage wheel brake system. The air system consists of two autonomous systems: the main and emergency systems, both of which are connected by a common charging airline. The compressed air supply of each system is provided by individual air tanks onboard the aircraft:

- main system - LM375Ya-P-50 11 liter tank;
- emergency system - LM375Ya-3-50 3 liter tank.

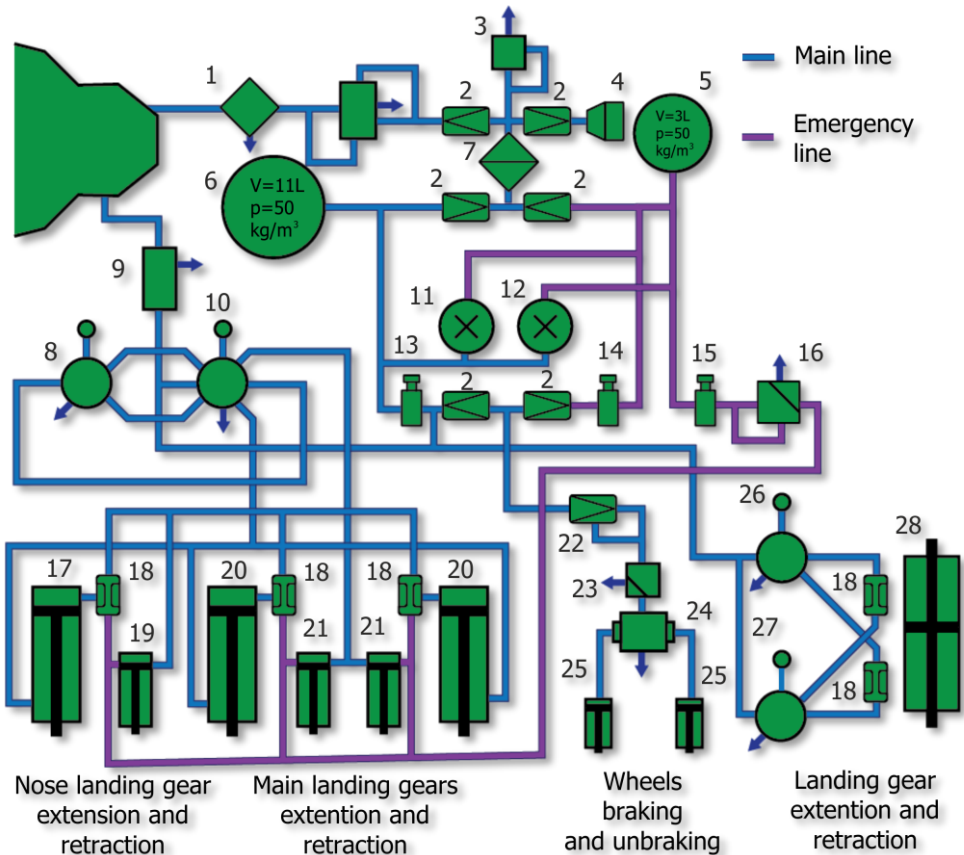

Figure 6. Schematic diagram of the air system.

1 - FT decanter; 2 - non-return valves; 3 - pressure reducing valve; 4 - filler valve; 5 - emergency system tank; 6 - main system tank; 7 - 31VF3A filter; 8 - 625300M three-way valve; 9 - EK-48 electro-pneumatic valve; 10 - undercarriage command crane; 11, 12 - 2M-80 manometers; 13 - 992AT valve (network charging); 14, 15 - 992AT-3 emergency undercarriage deployment valves; 16 - 562300 bleed valve; 17 - lift; 18 - emergency valves; 19 - undercarriage front strut lock release cylinder; 20 - undercarriage main strut lift; 21 - lock release cylinders; 22 - PU-7 (U139) pressure reducer valve; 23 - UP53 / 1M valve; 24 - PU-8 (V135) differential; 25 - brake wheels of the undercarriage main struts; 26, 27 - 625300M three-way valves; 28 - landing flap release/retract cylinder.

Cylinder filling is done by means of a 3509S59 common charging valve from the airfield cylinder using dry compressed air, with a dew point no higher than -50°C . The operating air pressure in both systems is 50 kg/cm^2 . While in flight, the tank of the main system is refilled using the AK-50A compressor installed on the engine.

The charging valve is installed on the left side of the fuselage between frames 10 and 11.

The pressure in the main and emergency systems is monitored by the 2M-80 double-barreled manometers mounted on the left panels of the instrument panels in both cabins. The tanks of the main and emergency systems are installed on the right side of the fuselage between frames 10 and 11.

A safety valve protects the air system from overloading by bleeding air through the openings in its housing into the atmosphere at a system pressure of greater than $70 \sim 100\text{ kg/cm}^2$, on which its spring is backed. The wiring of the air system consists of rigid pipelines, braided hoses, and connecting fittings.

Main system

The main air system consists of the LM375YA-11-50 main tank, the pipelines for charging and recharging the system, the 992ATZ system valve installed on the left panel in the first cabin, the 625300M undercarriage valve, the 525502-10 undercarriage command valve, the 625300M flap valve, the EK-48 electropneumatic valve, the U139 (PU-7) reducer valve, the UP53 / 1M brake release valve, the U135 (PU-8) compensation gear, and the 525701-10 flap cylinder equipped with two 524704-30 emergency valves. When the engine start button located on the left-side panel of the instrument dash in both cabins is pressed, the EK-48 electropneumatic valve mounted on frame 0 is activated and air is fed into the air distributor in order to start the engine. When deploying or retracting the undercarriage, compressed air enters the cylinders of the locks and lifters of the undercarriage through the undercarriage valves located in the instrument dashboards of both cabins. Both valves are connected by conduit pipes. The undercarriage valve in the second cabin is a command valve. Setting the valve handle to the neutral position allows for undercarriage deployment and retraction from the first cabin. In the event of an error in undercarriage control from the first cabin, the pilot in the second cabin, in correcting the error, sets the valve handle to the desired position while the undercarriage valve of the first cabin is simultaneously disconnected from the compressed air system. After this, the undercarriage can be deployed or retracted only from the second cabin. When deploying or retracting the flaps, compressed air through the 625300M valve enters the cylinder. Pressure from the valves of the first and second cabin is fed to the two cavities of the flap cylinder via the emergency valves. When applying brake pressure to the wheels, compressed air through the V139 (PU-7) valve (where air pressure is reduced from 50 kg/cm^2 to $8 + 1\text{ kg/cm}^2$ via the UP53 / 1M release valve connected to the control handle in the second cabin), enters the V135 (PU-8) compensation gear. From here it is distributed into the brakes of the right and left wheels of the main undercarriage legs. The pressure relief valve is controlled by the levers installed on the aircraft's control stick in both cabins. The U139 (PU-7) valve is installed on the wall of frame 7 under the floor of the second cabin. The V135 (PU-8) compensation gear, controlled by the foot pedals, allows for separate braking of the wheels. The compensation gear is attached to the wall of frame 5, while the UP 53 / 1M brake release valve is attached to the wall of frame 6.

Emergency system

Air from the emergency system tank is used in case of main system failure. When releasing the undercarriage, compressed air from the emergency system tank enters the lock cylinders and into the undercarriage lifts through the emergency valves. At the same time, compressed air approaches the pressure reduction valve, ensuring that the undercarriage wheels are braked using air from the emergency system. The 562300 pressure relief valve eliminates the back pressure phenomenon in the undercarriage lifts during their operation using the main system when the 992ATZ closed emergency valves are leaking. When opening the emergency release valve (at a pressure of greater than 5 kg/cm²), the bleed valve closes the outlet to the atmosphere.

Fuel System

The fuel system serves to hold the necessary fuel stock onboard the aircraft and to power the engine in all its modes of operation on all possible trajectories of the aircraft. B-91/115 GOST 1012-72 aviation gasoline is used to power the M-14P engine onboard the aircraft. Fuel is stored in two tanks with a capacity of 61 + 1 liters. These fuel tanks are located in the right and left wing consoles. The fuselage is also equipped with a storage tank with a capacity of 5,5⁺¹ liters, and this tank allows for engine operation during inverted flight and flight with negative G-loads. Fuel flows from the fuel tanks into the storage tank through the non-return valve block. Two non-return valves prevent the fuel from flowing from one fuel tank to another, and another is used to stop flow of fuel from the supply tank to the fuel tanks when the aircraft is diving.

Fuel from the supply tank flows into to the gasoline pump through the non-return valve that facilitates the operation of the filler syringe, the fire cock, and the gasoline filter. After passing through the pump, the fuel under pressure flows into the reserve tank, then into the engine carburetor to two fuel pressure sensors after passing through a fine mesh filter. Each sensor outputs signals to its own UK-1 gauge. The gauges and sensors are included in the three-arrow EMI-ZK electric engine gauge. The UKK-1 gauges are located on the instrument panels in both cabins, while the sensors are mounted on the wall of frame 0.

A filler syringe is used before starting the engine to feed fuel into the engine cylinders and fill the main fuel line. The handle of the syringe is located on the dashboard of the first cabin. When the handle is pulled back, the cavity of the syringe is filled with fuel coming from the main fuel line. The filler syringe also serves for emergency fuel supply when the pump fails.

The fuel delivery for oil dilution is supplied through a solenoid valve mounted on frame 0. The fuel feed to the valve is facilitated by a flexible pipeline connected to the outlet of the gasoline pump. The oil dilution valve switch is located on the dashboard of the first cabin. The reserve tank is connected by a pipeline to the supply tank for bleeding excess fuel and maintaining the set pressure at the front of the carburetor. There are two control valves in the pipeline. There is a drain cock at the lowest point of the fuel line between frames 5 and 6; this serves to drain the fuel sludge.

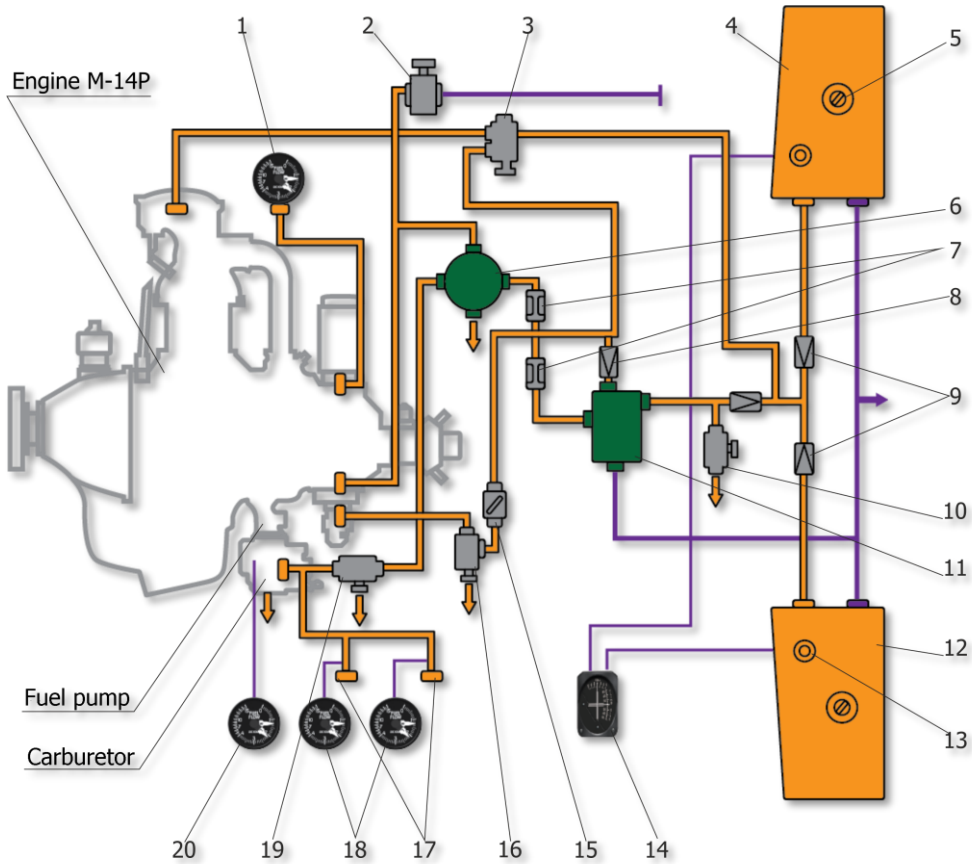

Figure 7. **Schematic diagram of the fuel system.**

1 - MV16K manovacuummeter; 2 - oil dilution valve; 3 - filler syringe; 4 - right fuel tank; 5 - filler neck; 6 - reserve tank; 7 - throttle valve; 8 - non-return valve; 9 - block of non-return valves; 10 - drain cock; 11 - supply tank; 12 - left fuel tank; 13 - DSU-1-2 fuel gauge sensor; 14 - IUT-3-1 fuel gauge; 15 - fire cock; 16 - gas filter; 17 - P-1B fuel pressure receiver; 18 - EMI-3K electric-motor indicators; 19 - fine mesh filter; 20 - TUE-48K mixture temperature indicator.

The amount of fuel in the tanks is monitored by a fuel level indicator that provides information in 9 increments about the fuel reserve in the two tanks on the indicator board. This set includes two DSU 1-2 indicator sensors and one IUTZ-1 indicator.

The sensors are located in the fuel tanks, while the indicator gauge is mounted on the dashboard in the first cabin. On the dashboard of the second cabin there are two signal lamps that light up when the signaling devices detect a reserve of 12 liters in their respective tanks. The emergency fuel balance is 24 liters.

Brief Description of the Aggregates

Oil system

The oil system of the aircraft is designed to provide lubrication for the friction parts of the engine and to cool the oil that is used. The M-14P engine uses MS-20 oil for lubrication (GOST 1013-49).

The oil system of the aircraft consists of a pump, a tank of 20 liters capacity, filters, a prompter tank, a radiator, the oil pipelines, the receivers, and two sets of oil pressure and temperature indicators. The oil system is equipped with a gasoline oil dilution system with a dilution valve. The oil circulation in the system is forced and is carried out by a two-stage gear pump installed on the back cover of the crankcase. The oil lines are made of flexible hoses and rigid pipelines.

During engine operation, the oil from the tank flows by gravity through a hose into the filter. Once filtered, the oil passes to the inlet of the oil pump. Then, the pump's main stage pumps pressurized oil into the engine. While inside the engine, the oil passes through the channels and through the gaps located between the rubbing surfaces of the parts and the nozzles of the directed lubrication fluid. Then the oil flows into the engine sump. From the engine sump and through the early warning FOD filter/detector, the oil is taken by the scavenge stage of the pump and is pumped through the radiator. Once cooled, the oil is fed back into the tank. Inside the tank, oil drains through the supply tube to the tray, where air separation (defoaming) occurs. The oil and air intake of the oil tank is made swinging for the uninterrupted operation of the oil system in all trajectories of the aircraft. The pressure and temperature of the oil entering the engine are controlled by electric engine gauges installed in both cabins of the aircraft. Two oil pressure sensors are mounted on the wall of frame 0.

To cool the oil in the system, an air-oil cooler with an adjustable cross-sectional area of the air outlet is installed on the aircraft. For the operation of the oil system in subzero conditions, a gasoline oil dilution system is in place, facilitating and accelerating the preparation of the engine for startup, and facilitating the startup process proper. The dilution system consists of a valve, the necessary pipelines, a pressure switch for controlling the dilution valve, and a metering nozzle of $\varnothing 1,5^{+01}$ mm.

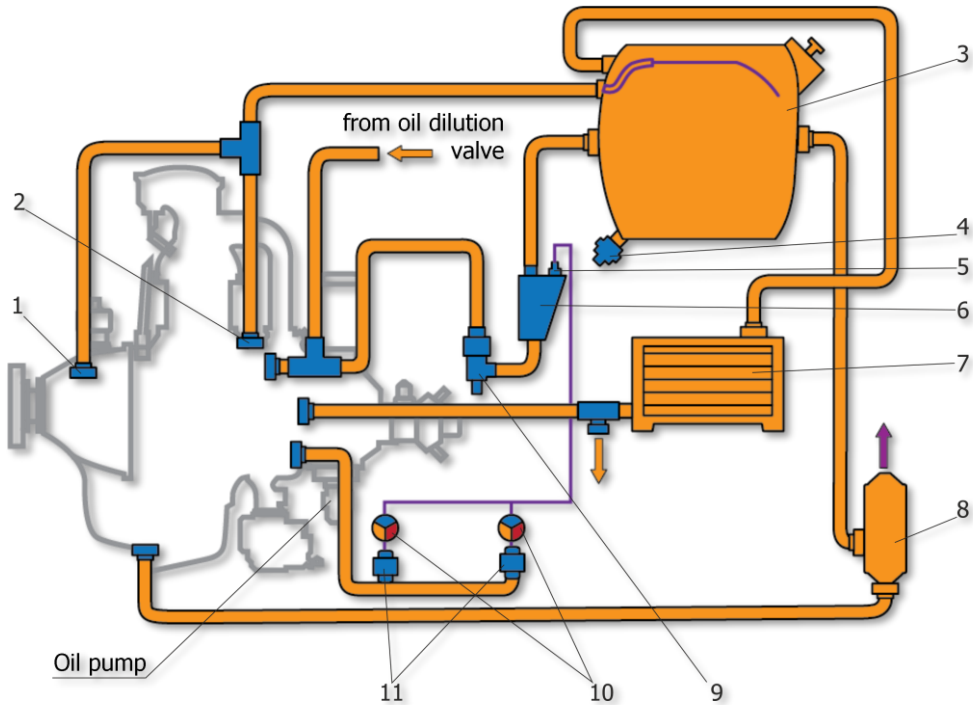

Figure 8. **Schematic diagram of the oil system.**

1 - front engine breather; 2 - rear engine breather; 3 - oil tank; 4 - oil tank drain valve; 5 - P-1 temperature receiver; 6 - oil tank; 7 - air-oil radiator; 8 - breather tank; 9 - oil filter; 10 - gauges from the EMR-3K set; 11 - P-15B oil pressure receiver.

Oil cooler cowling

The oil cooler is installed in the right wing console between ribs 1 and 2 just behind the spar and is attached using profiles. The oil cooler is covered by a removable cowling. The outlet of the cowling is itself closed by a controllable flap, which regulates the size of the oil cooler channel outlet. The flap is controlled mechanically: An lug is riveted to the flap to connect the flap control rod. The control wiring is made in the form of pull rods of a semi-rigid type. The flap control lever is installed in the cockpit, on the right-side panel.

Powerplant

The powerplant of the Yak-52 aircraft consists of an M-14P engine with a V530TA-D35 propeller, an engine frame, an exhaust manifold, the drives for controlling the engine and its subunits, plus the systems for engine cooling, engine starting, and the fuel and oil systems. The M14P aircraft engine is a four-stroke, gasoline-powered, air-cooled, nine-cylinder, single-row engine with a star-shaped arrangement of the cylinders and carburettor fuel-mixing process. The engine has a gear assembly for reducing the RPM of the propeller, and a centrifugal supercharger with a single-speed mechanical drive.

The engine is cooled by air coming through the louvres installed in the frontal part of the hood. Uniform cooling of the cylinders is ensured by the air deflectors installed on each cylinder. The engine parts are lubricated by pressurized oil and the engine is started by compressed air. The engine magneto and engine ignition wiring are shielded. The following units are installed on the engine for the maintenance of the various aircraft and engine systems: TTsT-13K temperature sensor, P-2 speed controller, the AK-14P carburetor, two M-9F magnetos, the 702ML gas pump, the AK-50A air compressor, the GSR-3000M generator, the MN-14A oil pump, a spool-type compressed air distributor, and the DTE-6T tachometer sensor. There are two spark plugs and one starting air valve on the head of each cylinder. The engine is attached to the nodes on the fuselage of the aircraft by means of the engine frame.

The engine dry weight is 214 + 2 % kg.

Engine exterior dimensions, in mm:

- | | |
|---|-------|
| • Diameter (by the ends of the valve system casing) | 985+3 |
| • Length | 924+3 |

V530TA-D35 propeller dimensions

- | | |
|-----------------------|--------|
| • Diameter | 2.4 m |
| • Number of blades | 2 |
| • Minimum blade angle | 14°30' |
| • Maximum blade angle | 34°30' |
| • Propeller weight | 40 kg |

Engine Cooling System

Cowl panel

The engine mounted on the aircraft is covered by a streamlined removable hood. It consists of the top and bottom covers, connected together by tightening locks. The surface of the top cover of the hood is inscribed in the fuselage contours. The rest of the hood protrudes beyond the contours, forming the air exit slot, which cools the engine cylinders, between the lining of the fuselage and the hood (at the trailing edge.)

Carburettor air scoop

On the lower flange of the carburettor there is an air intake for supplying heated air to the carburettor. The air intake consists of a filter canister, a suction pipe and a scoop. To the upper flange of the box, a suction pipe of a welded structure is attached to the hinge, which serves to supply air to the box heated when passing through the fins of the cylinders. The scoop is attached to the bottom flange of the canister providing an adjustable supply of cold air to the canister. The scoop is mechanically controlled by a lever mounted on the right-side console in the cockpit.

Shutters

The inlet of the cowling is shut off by controllable hinged armoured louvers, designed to control the amount of air supplied to cool the engine. These consist of an internal fixed disk, a movable ring, the flaps, and an external fixed ring. The flaps are riveted with steel leashes that extend into the movable ring. When the ring turns, the bolts turn the leashes and, with them, the flaps of the system. The rotation of the movable ring and, consequently, the angle of deflection of the flaps is limited by the mechanical restraint located on the fixed disk. To eliminate vibrations, the flaps are connected in pairs by springs. The blinds are controlled by means of semi-rigid pull rods. The flap control lever is located on the right-side console in the cockpit.

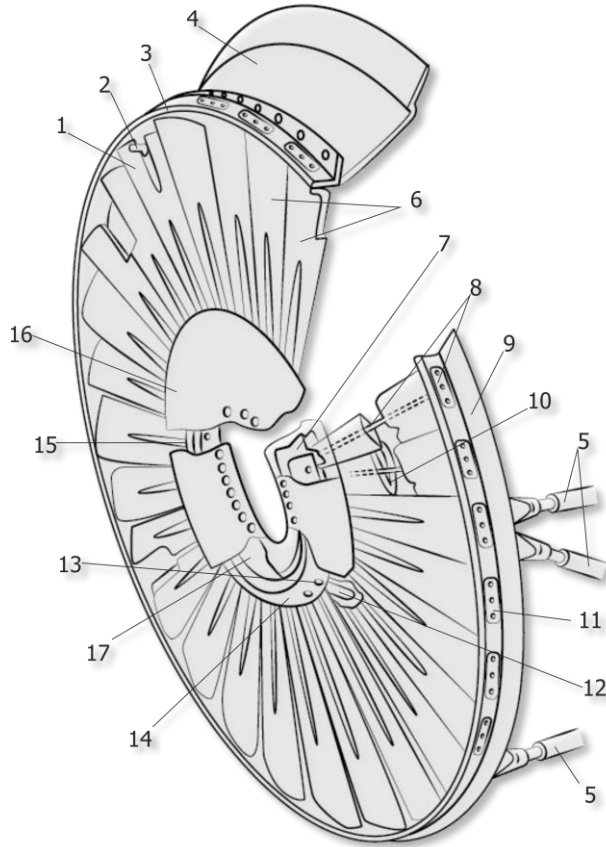

Figure 9. **Shutters.**

1 - detachable half-door; 2 - bolt; 3 - lining; 4 - glare shield; 5 - tubular slanting; 6 - half-doors; 7 - bellcrank; 8 - rung; 9 - ring; 10 - spring; 11 - disk; 12 - control rod mounting bracket; 13 - ball bearing; 14 - movable ring; 15 - support; 16 - fairing disk; 17 - guide rail

To improve the organization of the engine cooling air flow through the flaps/shutters, a 420 mm disc cowling is installed on the inner movable ring of the flaps, and a guide rail is attached to the outer ring and blinds at the top, improving the cooling of the uppermost engine cylinders. There are three cutouts in the louvre boards for the intake manifolds of the generator, compressor, and cabin ventilation.

Exhaust housing

The exhaust manifold is designed to collect the exhaust gases from the engine cylinders and divert them to the fireproof zone. It consists of two separate parts: the right part of the collector joins five cylinders of the engine while the left part joins four. Each part of the collector is made up of separate sections made of stainless steel sheets and connected together with clamps (and) sealing gaskets. The joints of the sections are reinforced with welded sleeves. To one of the sections of the collector, ribs are welded evenly along the circumference to increase the heat transfer surface. The heater cover of the cabin heating system is fixed to this section. The collector is fixed to the engine by means of seating nipples (welded to the sections), coupling nuts, and elastic sealing rings.

Compressor air cooling system

Compressor cooling is provided by outboard air with the help of the forced air cooling system, consisting of the intake manifold (with an inlet spigot) and the tail pipe, directing the outboard air to the compressor cylinder. The intake pipe is attached to the fixed shutter ring (against the cutout in the doors) by a flared bell and is telescopically connected to the pipe fixed by the flange to the engine deflector. The other end of the pipe is connected to the nozzle by means of a clamp, directly cooling the compressor. This sleeve is fixed to the strut of the engine frame by means of a clamp.

Generator air cooling system

The generator is cooled by the incoming air flow. Two branch pipes - intake and outlet - serve this purpose. Air intake takes place through the window cut out in the louvre boards and is not dependent on the louvre position.

Engine control and aggregates

Engine and engine aggregate control is divided into the following sections: motor speed control (gas), propeller pitch, fire cock, mixture heating, hood shutters and the louvre of the oil cooler tunnel outlet duct. Motor speed control, propeller pitch control, and fire cock control are available in both cabins and are provided by levers installed on the left-side panels. Mixture heating, the hood shutters, and the louvre of the oil cooler tunnel outlet duct are controlled from the first cabin by means of the levers installed on the right-side panel. The wiring of the engine management system consists of semi-rigid traction rods. The rodding is made of steel cables enclosed in duralumin guide tubes and are connected to the control levers of the engine and its units by means of ball-and-socket joints and shunting forks. The rodding is fixed to the fuselage by means of blocks which are installed at both ends of the bends.

Brake friction levers are installed on the control panels for propeller pitch and engine speed. These regulate the lever travel force or fix them in the position set by the pilot. The control levers of the engine and engine units operate in the following manner: when pushed forward, gas is increased, propeller pitch is decreased (fine pitch), and the fire cock, the mixture heating flap, the oil cooler tunnel flaps and the hood louvres open. When the lever is pulled backwards: the engine stops, propeller pitch increases (coarse pitch), and the fire cock, the mixture heating flap, the oil cooler tunnel flaps and the hood louvres are closed.

Aircraft Propeller (V-530TA-D35)

Propeller design and function

The Yak-52 is outfitted with a M-14P engine equipped with a V-530TA-D35 model propeller, in conjunction with a R-2 (or R-7E) constant-speed regulator. The propeller maintains the constant speed set by the pilot in all flight modes, ensuring that the engine outputs full power at any given flight mode.

The automatic operation of the propeller is based on the hydrocentrifugal principle in a direct operating scheme with single-channel oil feed into the cylinder group of the propeller. Transition of the propeller into idle mode is performed through antitorque moment created by the oil pressure entering the propeller cylinder from the oil pump of the P-2 regulator. Transition of the propeller into high pitch is also through antitorque moment created by the centrifugal forces of the counterweights. When the pressure of the oil coming from the regulator to the propeller falls, the propeller blades, under the centrifugal forces of the counterweights, come to the high-pitch stop, ensuring the continuation of flight. A heater is installed on the propeller cylinders during low-temperature conditions.

Technical Details

• Engine reduction	0.79
• Propeller rotational direction	CCW
• Propeller diameter	2.4 m
• Number of blades	2
• Blade shape	Oar-shaped
• Blade thickness ratio	0.08
• Maximum blade width	240 mm
• Minimum blade installation angle	12°
• Maximum blade installation angle	28°30' ±1°
• Blade rotation range	16°30' ±1°
• Propeller mode of functioning	Hydrocentrifugal
• Mechanism	Straight
• Constant-speed unit	R-2/R-7E
• Counterweight angle of pitch	20°
• Gross propeller unit weight (plus components not present on an installed propeller unit)	39 kg±2%

Mechanism

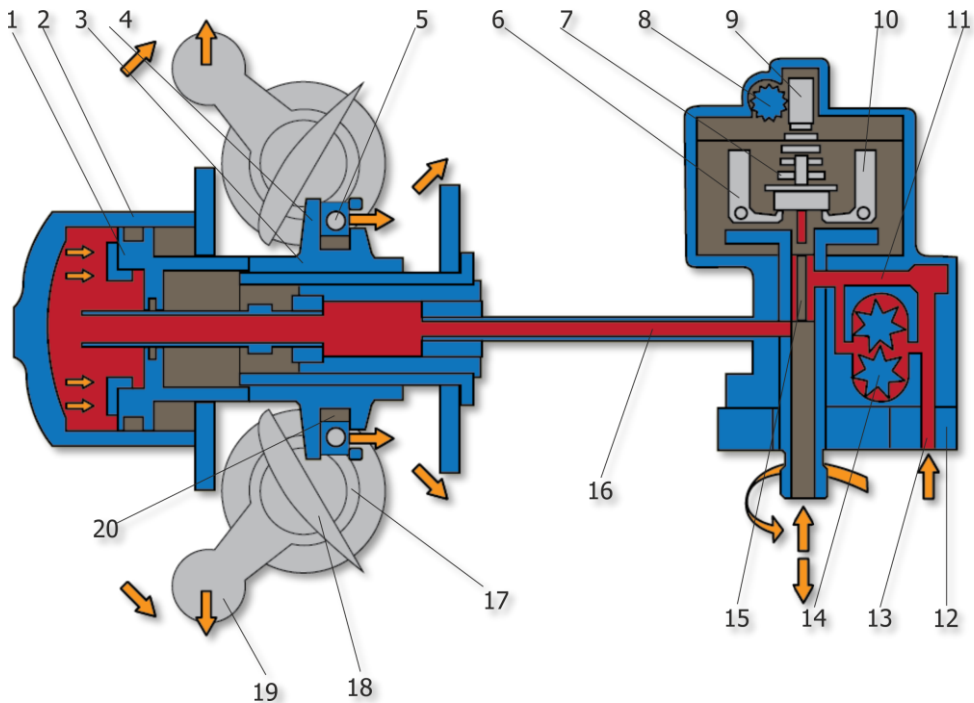

Figure 10. **Propeller action diagram (engine on-speed).**

1 - piston; 2 - cylinder; 3 - scissor; 4 - scissor eye lugs; 5 - axis pin; 6 - centrifugal weight axes; 7 - spring; 8 - cogwheel; 9 - crown; 10 - centrifugal weights; 11 - oil outlet through the pressure relief valve; 12 - regulator case; 13 - oil supply channel from the engine; 14 - regulator oil pump; 15 - slide valve; 16 - oil supply channel to the cylinder; 17 - cup; 18 - blade; 19 - counterweight; 20 - socket.

The V-530-D35 propeller operates in a direct operating mode. The rotation of the blades, when coarsening the pitch, occurs under the action of the moments created by the centrifugal forces of the counterweights; during fine pitch, rotation occurs under the action of the moments created by oil pressure in the piston of the propeller cylinder group. The oil pressure, supplied by the oil pump of the steady speed regulator, overcomes the centrifugal moment of the counterweights and turns the blades to reduce the pitch. During propeller rotation, the counterweights, mounted on the transfer cups, create a moment which has a tendency to turn the blades into an increase in pitch in all operating modes of the engine. The joint operation of the propeller and the regulator ensures the automatic change in propeller pitch, thus maintaining the predetermined constant speed of the engine regardless of the active flight mode and engine operation mode.

The set value of the constant RPM, which the propeller must support in conjunction with the regulator, is realized by the corresponding adjustment of the regulator. Adjustment of the regulator is done by rotating the RPM regulator hand wheel (directly connected to the regulator) located in the pilot cabin.

When making changes to the flight mode or engine power, engine speed may deviate from the set speed by 150-200 RPM, but will normalize within 3-4 seconds.

The forced switching of blade pitch is performed by the pilot using the hand wheel located in the cabin. In order to transition the propeller into fine pitch, the hand wheel of the RPM controller must be turned fully, away from the pilot. To transition to coarse pitch (reduce the propeller RPM): without touching the throttle lever, the regulator hand wheel must be turned fully, towards the pilot.

Propeller construction

The V-530-D11 and V-530-D35 model propellers are made with wooden blades, consisting of two parts: a metal cup and a wooden airfoil. The wooden airfoil of the blade is made of pine boards, and the blade root, included in the metal cup, is made of moulded impregnated wood, capable of withstanding the tensile and bending loads that occur when the propeller is being operated by the engine.

The pine boards are collected and glued from planks with a width of 20-70 mm, after which are stuck together lengthwise with the moulded impregnated wood boards with a long weave joint. The length of the weave joint with respect to the thickness of the boards to be bonded is 1:20. VIAM BZ glue is used to fix the pine wood planks to the boards and the weave joint. To increase the strength of the trunkleg part of the propeller blade and the glue area of the moulded impregnated wood scarf joint, a part of the moulded impregnated wood protrudes from the metal cup and extends to the blade paddle.

To increase the strength and stiffness of the propeller blade, its treated surface is covered with two layers of birch aviation plywood. Plywood is glued to the blade at an angle of 45° to the axis of the blade with the use of special presses, ensuring the tight fit of the plywood to the blade.

COCKPIT



COCKPIT

Front Cockpit

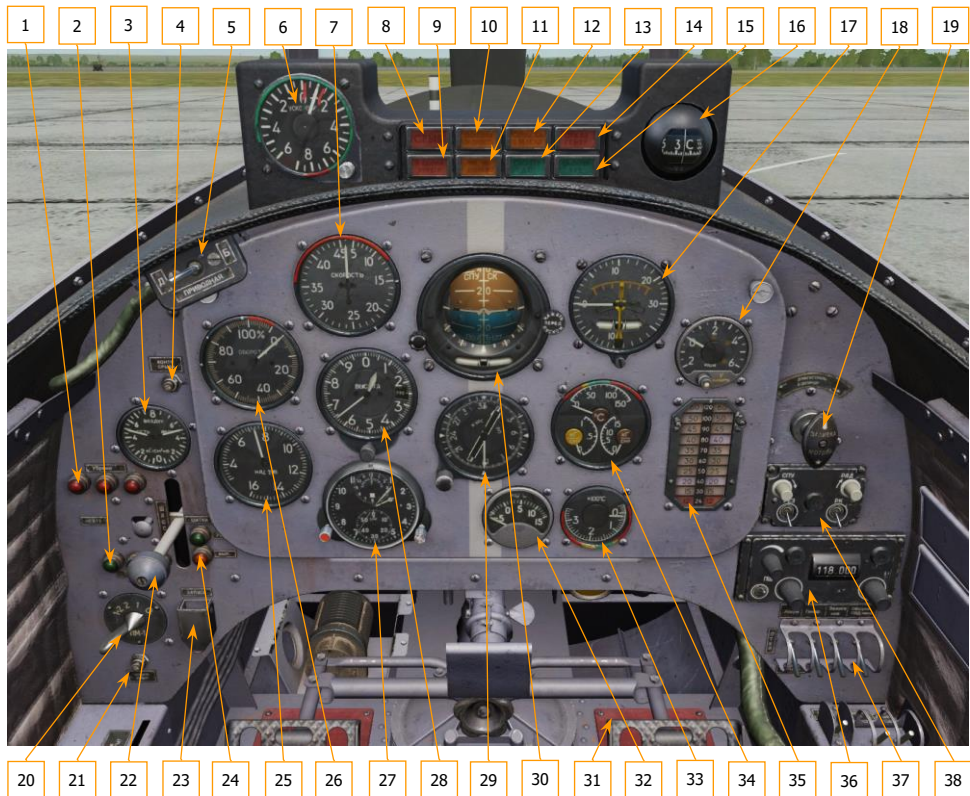

Figure 11. Front cabin instrument dashboard.

- | | |
|--|--|
| 1. "UNDERCARRIAGE DEPLOYED" signal light | 9. G-Limit warning light |
| 2. "UNDERCARRIAGE RETRACTED" signal light | 10. Overturning speed warning light |
| 3. 2M-80K dual pressure compressed air manometer | 11. "DO NOT USE GYROMAGNETIC COMPASS" signal light |
| 4. Stall monitor switch | 12. FOD IN OIL warning light |
| 5. Aircraft emergency locator switch | 13. "FAILURE SENSOR WARMUP" signal light |
| 6. AM-9S accelerometer | 14. Generator failure warning light |
| 7. US-450K airspeed indicator | 15. Pitot heat warning light |
| 8. "FAILURE" warning light | 16. KI-13K magnetic compass |

- | | |
|--|--|
| 17. DA-30 rate-of-climb, turn and slip indicator | 29. UGR-4UK angle-of-turn indicator (from the GMK-1A directional heading system package) |
| 18. VA-2K voltamperemeter | 30. AGI-1K artificial horizon |
| 19. Priming pump | 31. Rudder pedals |
| 20. PM-1 magneto switch | 32. TUE-48K mixture temperature gauge |
| 21. Test light button | 33. TTsT-13K cylinder temperature gauge |
| 22. Undercarriage deployment/retraction lever | 34. EMI-3K electrical engine gauge |
| 23. Engine start button | 35. IUT-3-1 fuel gauge |
| 24. Flaps status signal light | 36. "LANDYSH 5" radio-station control panel |
| 25. MV-16K manovacuumeter | 37. Automatic circuit breaker switchboard |
| 26. ITE-1K tachometer | 38. SPU-9 receiver panel board |
| 27. AChS-1K aviation clock | |
| 28. VD-10K altimeter | |

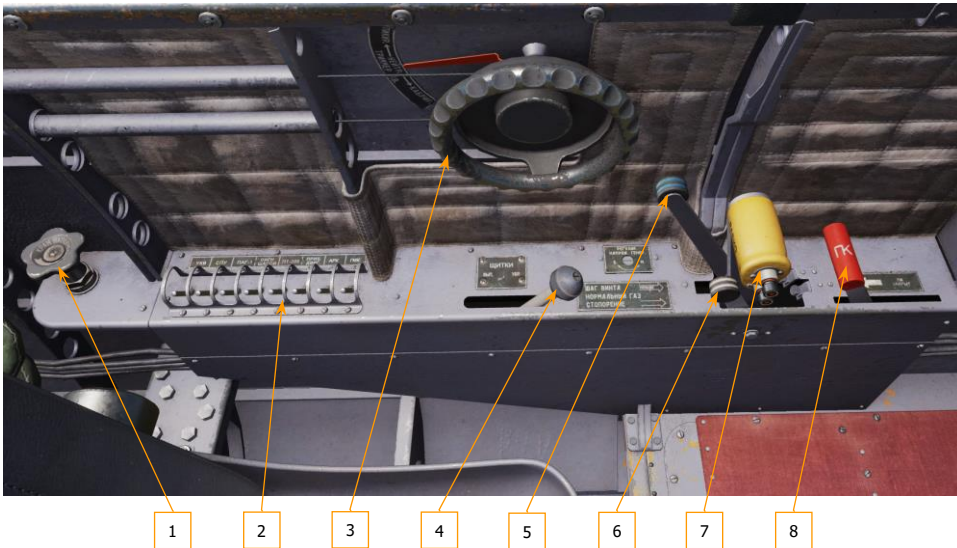

Figure 12. **Front cabin left-side panel.**

- | | |
|--------------------------------|---|
| 1. Air system valve | 6. Lock lever |
| 2. Circuit breaker switchboard | 7. Carburettor throttle lever (with VHF and intercom buttons) |
| 3. Trimmer hand wheel | 8. Fuel emergency shut-off cock lever |
| 4. Landing flaps control lever | |
| 5. Propeller pitch lever | |

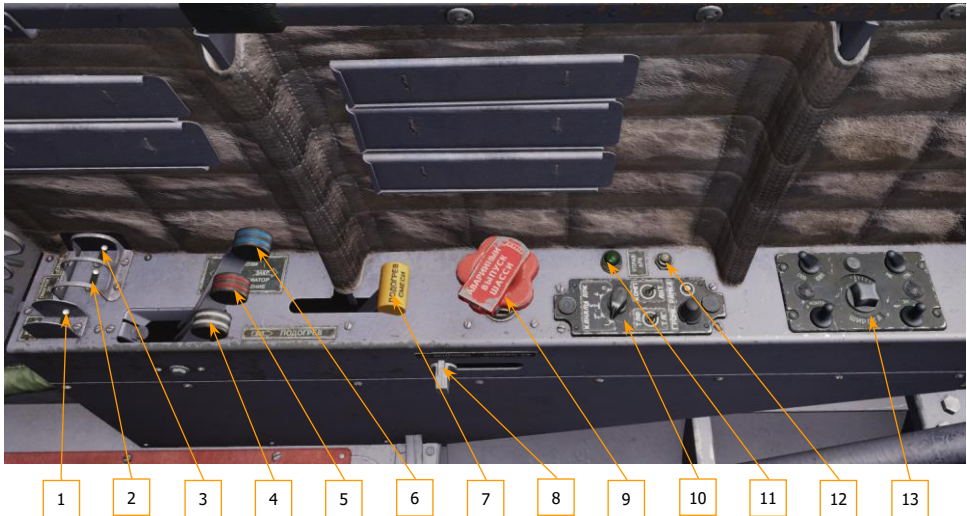

Figure 13. **Front cabin right-side panel.**

- | | |
|---------------------------------------|---|
| 1. Oil dilution tumbler | 8. Ventilation control lever |
| 2. Failure sensor warm-up activator | 9. Emergency undercarriage deployment valve |
| 3. Failure sensor activator | 10. ARK-15M radio compass control panel |
| 4. Lock lever | 11. Radio compass signal light |
| 5. Oil-cooler half-door control lever | 12. Radio compass button |
| 6. Louvre shutter control lever | 13. PU-26 control panel (from the GMK-1A set) |
| 7. Charge heating control lever | |

Rear Cabin



Figure 14. Rear cabin instrument dashboard

- | | |
|---|--|
| 1. Aircraft emergency locator switch | 10. "DO NOT USE GYROMETRIC COMPASS" signal light |
| 2. ITE-1K tachometer | 11. "FAILURE" warning light |
| 3. US-450K airspeed indicator | 12. Signal light, left tank 12L remaining |
| 4. AM-9S accelerometer | 13. Overturning speed warning light |
| 5. "PITOT TUBE WARMUP" signal light | 14. "FOD IN OIL" warning light |
| 6. "BATTERY ON" signal light | 15. Signal light, right tank 12L remaining |
| 7. "GENERATOR FAILURE" signal light | 16. "OVERTURNING SPEED" warning light |
| 8. "CRITICAL OVERHEAT" signal light | 17. KI-13K magnetic compass |
| 9. "FAILURE SENSOR WARMUP" signal light | 18. AChS-1K aviation clock |

- | | |
|---|--|
| 19. SPU-9 receiver panel board | 29. 2M-80K dual pressure compressed air manometer |
| 20. "UNDERCARRIAGE RETRACTED" signal light | 30. VD-10K altimeter |
| 21. "UNDERCARRIAGE DEPLOYED" signal lamp | 31. Rudder pedals |
| 22. Signal light button | 32. UGR-4UK angle-of-turn indicator (from the GMK-1A directional heading system package) |
| 23. PM-1 magneto switch | 33. AGI-1K artificial horizon |
| 24. Engine start button | 34. EMI-3K electrical engine gauge |
| 25. Undercarriage deployment/retraction lever | 35. DA-30 rate-of-climb, turn and slip indicator |
| 26. Undercarriage valve locking device | 36. TTsT-13K cylinder temperature gauge |
| 27. Ignition switch | 37. Electrical panel for device failure simulation |
| 28. "FLAPS DEPLOYED/RETRACTED" signal light | |

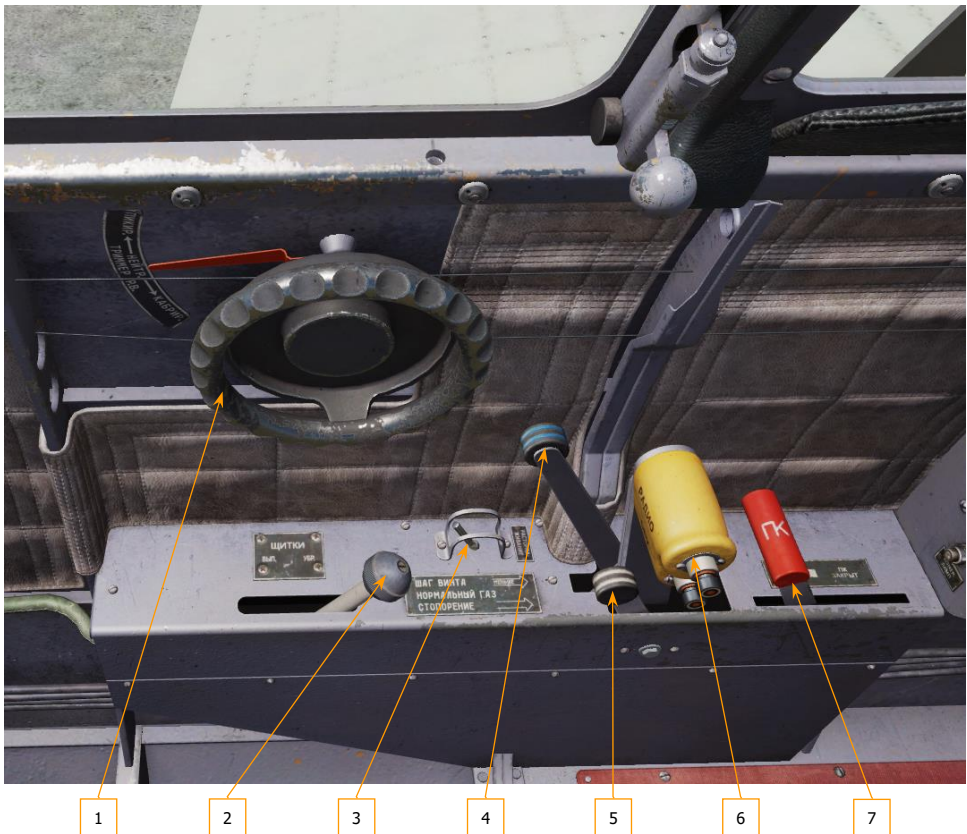

Figure 15. **Rear cabin left-side panel.**

- | | |
|-----------------------|--------------------------------|
| 1. Trimmer hand wheel | 2. Landing flaps control lever |
|-----------------------|--------------------------------|

3. Brake release switch
4. Propeller pitch lever
5. Lock lever
6. Carburettor throttle lever (with RADIO and SPU buttons)
7. Fuel emergency shut-off cock lever

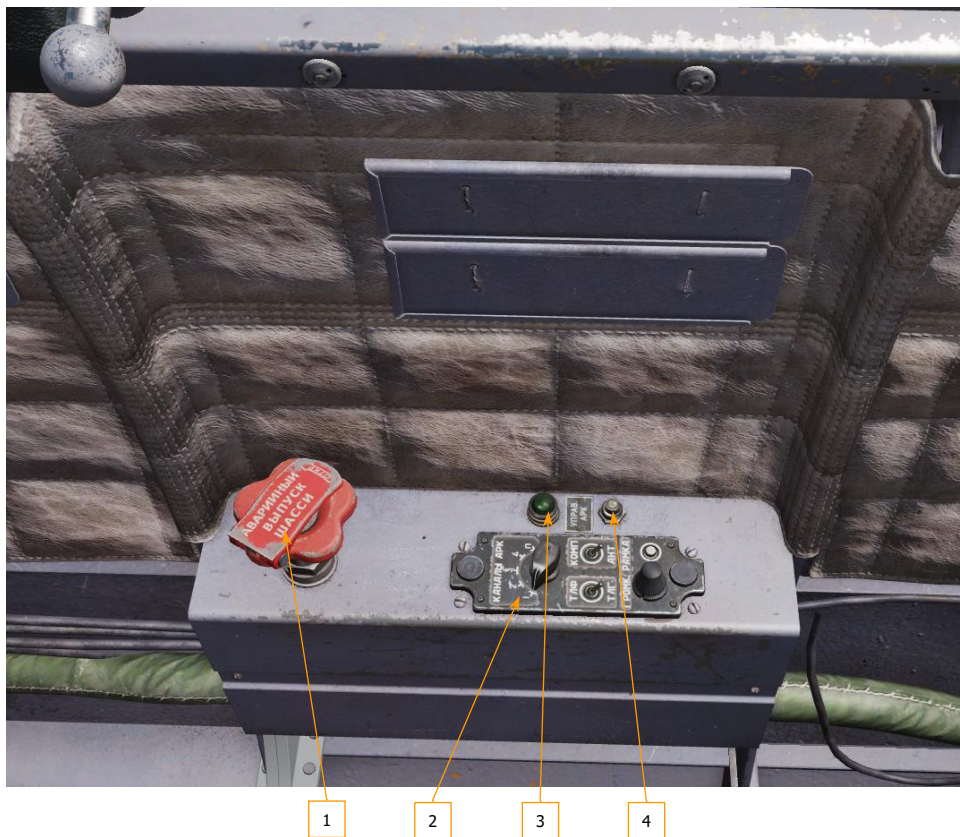

Figure 16. **Rear cabin right-side panel.**

1. Emergency undercarriage deployment valve
2. ARK-15M radio compass control panel
3. Radio compass signal light
4. Radio compass button

FLIGHT CHARACTERISTICS



FLIGHT CHARACTERISTICS

Yak-52 Flight Characteristics

The aircraft's maximum indicated airspeed for level flight at an altitude of 500 m on the engine's takeoff mode is 300 km/h.

The aircraft's maximum operational range, at an altitude of 500 m and with a speed of 190 km/h, with a takeoff weight of 1290 kg, a fuel reserve of 119L, and with a fuel balance of 10% is 510 km with a flight time of 2 h 45 min.

The maximum operational range of the aircraft, when equipped with a skid landing gear (in the single-seat ferry variant) at an altitude of 500 m and a speed of 175 km/h is 435 km.

The aircraft's stall speeds during engine idling is shown in the following table.

- | | |
|-----------------------|----------|
| • Direct flight | 110 km/h |
| • Inverted flight | 140 km/h |
| • With flaps deployed | 100 km/h |

The aircraft's unstick distance, with speed of separation from the ground at 120 km/h, is 180 m.

The length of the aircraft's landing roll, with a touchdown speed of 115 km/h, is 300 m.

Operational Limitations

The aircraft's maximum allowable speed is 420 km/h.

The aircraft's never-exceed speed for performing flight maneuvers is 320 km/h.

Variants of the Yak-52 outfitted with wheeled undercarriages have the following G-load limits:

Positive-G	7
Negative-G	5

Aerobatic flight is prohibited when the remaining fuel balance is at 20 litres or less.

Never-exceed speeds:

With undercarriage deployed	200 km/h
With landing flaps deployed	170 km/h

Due to the lack of oxygen supply equipment on the aircraft, flights at altitudes of greater than 4000 m are prohibited.

Maximum windspeeds on takeoff and landing:

Headwind component	15 m/s
Crosswind component under 90 °	6 m/s

Minimum allowable level-flight speeds for the prevention of unintentional stalling:

Direct flight	130 km/h
Inverted flight	170 km/h

Continuous inverted flight on the aircraft can be performed for no longer than 2 minutes.

Note: Returning to inverted flight after the two-minute maximum is permissible only after 3 minutes of direct flight.

When the aircraft undercarriage is deployed, inverted flight and aerobatic maneuvers are **strictly prohibited**.

Mass and Alignment

Table 2. **Yak-52 mass and alignment data.**

Aircraft characteristic	Wheeled under-carriage variant	Ski undercarriage variant
Aircraft empty weight, in kg	1035	1075
Maximum takeoff weight, in kg	1315	1355
Maximum landing weight, in kg	1315	1355
<i>Full load, in kg:</i>		
Air crew, with S-4U parachute	180	180
Fuel	90	90
Oil	10	10
Permissible centre-of-gravity range, %MAC	17.5 - 27	15 - 27
Aircraft centre-of-gravity, undercarriage deployed, %MAC	19.0	18.8

1) MAC = Mean Aerodynamic Chord

M-14P Engine Specifications

Engine designation	M-14P
Cooling system	Air-cooled
Number of cylinders	9
Cylinder arrangement	single-row radial
Compression ratio	6.3 ± 0,1
Propeller rotation direction (in the direction of flight)	Left
Propeller type	V530TA - D35
Engine critical altitude	Sea-level engine
Engine max power	360 -2% HP
Continuous engine running time:	
Takeoff mode	No longer than 5min
At maximum RPM	No longer than 1min
All remaining modes	Indefinite
Idle (26%) to takeoff mode transition time	Up to 3 seconds
Engine overspeed (no longer than 1 second)	109%
Engine operation in inverted flight operation mode	nominal
Continuous operation time	No longer than 2min
Fuel grade	B-91/115 aviation gasoline
Octane grade	No less than 91
MS-20 Oil grade	GOST 1013-49
Oil pressure at engine inlet	4 - 6 kg/cm ²
Minimum allowable oil pressure	1 kg/cm ²
Oil temperature at engine inlet, °C:	
Minimum permissible	40 °C
Recommended	50-65 °C
Maximum on prolonged engine operation	75 °C
maximum permissible for no longer than 15min of continuous operation	85 °C
Cylinder head temperature °C:	
Recommended	140-190
Maximum on prolonged engine operation	220
Maximum allowable on takeoff and climb modes	
no longer than 15 min. and no more than 5% from engine lifespan	240
Minimum allowable for normal engine operation	120
Recommended air temperature at carburettor inlet, °C	10-45
Fuel pressure in front of the carburettor, kg/cm²	
At minimal RPM	No less than 0.15
under normal operating conditions	0.2-0.5
Engine operation while inverted	
Nominal operating mode: continuous operating time in minutes	No more than 2

Oil temperature at engine inlet

Oil temperature in °C:

Minimum permissible	40
Recommended	50-65
Maximum permissible on prolonged engine operation	75
Maximum permissible for no longer than 15min of continuous operation	85

Cylinder head temperature

Cylinder temperatures in °C:

Minimum allowable for normal engine operation	120
Recommended	140-190
Maximum permissible on prolonged engine operation	220
Maximum allowable on takeoff and climb modes no longer than 15 min. and no more than 5% from engine lifespan	240

Engine modes of operation

Table 3. **Engine modes of operation.**

Mode	Engine RPM, %	Pressure			Temperature, °C			Specific fuel consumption, g/Hp•hr
		Pressurization, mmHg	Fuel, kgf/cm ²	Oil, kgf/cm ²	Cylinder heads	Air at carburetor inlet	Oil at engine inlet	
Takeoff	99 ± 1	125±15 (of B)	0.2-0.5	4 - 6	120 - 220	+10 - +45	40 - 75	285 - 315
1. Maximum continuous power	82 ± 1	95±15 (of B)	0.2-0.5	4 - 6	120 - 220	+10 - +45	40 - 75	280 - 310
2. Maximum continuous power	70 ± 1	75±15 (of B)	0.2-0.5	4 - 6	120 - 220	+10 - +45	40 - 75	265 - 300
1. Cruising	64 ± 1	735±15	0.2-0.5	4 - 6	120 - 220	+10 - +45	40 - 75	215 - 235
2. Cruising	59 ± 1	670±15	0.2-0.5	4 - 6	120 - 220	+10 - +45	40 - 75	210 - 230
Idle	Not exceeding 26	-	No less than 0.15	No less than 1.0	-	-	-	-

Note:

1. Maximum permissible cylinder head temperature is 240°C (up to 15 minutes continuous).
2. Maximum permissible oil temperature at engine inlet is 85°C (up to 15 minutes continuous).
3. of B = on top of Barometric pressure

Fuel consumption data

Table 4. **Fuel consumption during different modes of flight.**

Flight phase	Fuel consumption, L	Time, min.	Distance covered, km
Start-up, warm-up, engine testing and taxiing	2	5	--
Takeoff and climb to 500 m	3	2	3
Descent from 500 m	0.5	1	2.5
Circular flight at an IAS of 180 km/h	4	5	--

Note.

- Fuel reserves = 120 L
 Emergency reserves of 10% - 12 L
 Fuel density - 0.75 kg/L

FLIGHT PREPARATION



STARTUP AND TAXIING

Pre-engine start-up checklist

The following are additional actions that are best performed during startup immediately after a landing.

Check the rear cockpit and ensure the following:

- Set the ignition switch to «1 кабина» (Up).



- Set the magneto switch to 1+2.



- Undercarriage lever to neutral and locked in place.



- Brake release circuit breaker set to off («Выкл.»).



- Landing flap lever to neutral.



- Flip switches on the failure simulator panel set to off.



Perform the following inside the front cabin just before startup:

- Ensure that all circuit breakers are switched off.



- Ensure that the flap lever is set to neutral.



- Ensure that the magneto is switched off, and that the engine start-up button is covered up.



- Ensure that the undercarriage lever is set to the deployed position (down) and locked in place.



- Ensure that the circuit breakers on the right-hand panel are all switched off.



- Ensure that the brake lever is locked in place.



- Check whether the sliding part of the canopy is easy to open and close, and if the canopy locks are able to be secured and released.



- Check the ease of use for the control stick and rudder pedals, and observe the deflection of the control surfaces.



- Check the ease of use and correct deflection of the elevator trimmer. For calibration, set the trimmer wheel to 1/3 of its maximum distance away from the pilot.



- Check the external status of the aircraft's navigation and flight instruments. Check the readings of the KI-13 magnetic and instrument compass, which should display the aircraft's ramp heading.



- Reset the G-load indicator to neutral.



- Set the altimeter arrows to zero, while the pressure readings on the instrument scale must coincide with the actual ground pressure or have a deviation of no greater than 1.5 mm Hg.



- Check the clock and, if necessary, calibrate to the exact time.



- On the radio control panel, set the noise suppressor switch to "Off" (down), and the volume control to the maximum volume position.



- Open the valve of the air system.

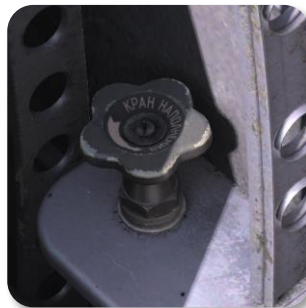

- Check the air pressure in the main and emergency side cylinders, which must be at least 50 kgf/cm²



- Check the ease of use for the levers controlling the engine and propeller.



- Check the ease of use of the fuel emergency shut-off lever. After checking, it should be set to the open position (completely away from the pilot).



- Check whether the following are able to be fully closed and opened: engine hood shutters, oil cooler tunnel flaps and the flaps for air heating at the carburettor inlet.



Inspect the instruments and ensure their correct operation:

- Signal the ground crews to connect the aircraft to the airfield power source. Set the power source switch to the battery position (Аккумулятор).



- On the artificial horizon, find and press the switch labelled "press before start-up".



- Switch on the circuit breakers for the PT-200 and gyromagnetic compass.



- Press the button on the on-board voltamperemeter. The reading on the instrument should show a value no less than 24 V.



- Set the power source switch to the airfield power source position (Аэр. Пит.)



- Check the voltage from the airfield power source (should be 27 V.)



- Switch on the circuit breakers for the VHF, aircraft intercom, undercarriage status signal, engine systems, ADF, compass, stall signal, and by pressing the indicator light button. Check the following:



- undercarriage signal lights. If the light is green, the signal lamps are working properly;



- Indicator panel, and the lights for flaps status, undercarriage retracted, over-G warning, stall, hazardous speed, FOD warning, generator failure, Do not use gyromagnetic compass, pitot warm-up, stall warning warm-up.



- Check the following:
 - Fuel reserves in the aircraft - the fuel gauge should show the actual amount of fuel in the tanks;
 - Correct operation of the fuel gauge warning lights - check by pressing the fuel gauge control button;



- After checking the above, switch off all the circuit breakers located on the left-side panel.



- Switch off all circuit breakers on the right-side panel.



Engine start-up checklist

The pilot must ensure that all items in this checklist are accounted for prior to engine startup.

Procedure:

- Set the throttle lever to the position corresponding to 1/3 of its full range - around 28 to 38%.
- Set the engine RPM control lever to the "fine pitch" position.
- Set the fuel emergency shut-off cock control lever to the open position (completely away from the pilot).

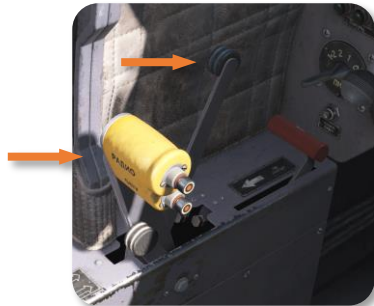

- Ensure that the magneto is off (the switch is in the "0" position).



- Ensure that the circuit breakers on the right-hand panel are switched off.



- Switch on charge heating.
If the air temperature is below zero, switch on the carburettor inlet air heating (by pulling back on the shutter control lever).



- Signal the aircraft engineering crew to crank the propeller. During this process, inject fuel into the engine using the primer (5-6 during summer, 8-12 during winter) set to "cylinder primer" mode.



Propeller cranking is necessary when the engine is running cold, but forbidden when running hot. Refrain from injecting more fuel than the specified amount, as this can lead to hydraulic shock.

Engine Start-up Procedure

This is the procedure for starting up the engine.

Procedure:

- Switch on the circuit breakers for the under-carriage status system and engine instruments.



- Switch on all circuit breakers on the right-hand panel.



- Set the primer to "pipeline fill" mode and increase gasoline pressure at the carburettor inlet to 0.2 - 0.5 kgf / cm².



- Flip open the safety cover of the "start-up" button and depress it fully for a duration of 3-5 seconds.



- While still holding down the start-up button and after the propeller rotates for 3-5 turns, switch on the magneto (with the switch set to "1+2"). To improve the start of the engine after the first flashes, additional fuel must be injected into the cylinders with the filling syringe.



- After the engine stabilizes, release the start-up button and move the throttle lever to to about 38 - 41% of its full range while observing the oil pressure on the pressure gauge.

If the oil pressure does not reach 1 kg_F / cm² for 15 - 20 s after start-up, immediately switch off the engine and determine the cause.



- After starting the engine, close the handle of the filler syringe.



Engine Warmup

It is recommended to warm up the engine after EVERY cold start, especially during the colder seasons.

Before proceeding to engine start-up, perform the following:

- Set the control stick and the rudder pedals to the neutral position;
- Press the brake lever

Warm up the engine at an RPM of 41 - 44%, until the oil temperature at the engine inlet starts to rise. When the oil temperature begins to increase, increase the RPM to 44 - 48%, (to 51% during winter) and warm up the engine at this RPM until the cylinder head temperature is at least 120 ° C, and the engine oil temperature is at least 40 ° C



In order to speed up the warm-up of the engine during winter, the nose shutters and the oil cooler flap must be kept closed. The engine is considered warm when the temperature of the cylinder heads is not lower than 120 ° C, and when the oil temperature at the engine inlet is at least 40 ° C.



Boot-up and Inspection - AGI-1

Additional measures before startup.

Perform the following:

- Switch on the circuit breaker for the AGI-1.



- Monitor the readings of the instrument. After about 1 minute after activation, the HSI should show the position of the aircraft relative to the horizon.



Boot-up and Inspection - Radio Station

- Switch on the circuit breakers for the VHF and aircraft wireless intercom on the switchboard. The radio is ready for operation 2 minutes after switching on.



- Double-check the list of required communication channels on the radio station control panel by establishing a connection with the ground radio station, or, in the absence of the ground station, by using the radio's interior noise and sidetone during transmission operations.



Inspection - ARK-15M Automatic Direction Finder

Procedure:

- Switch on the circuit breaker assemblies for the PT-200 and the ADF.



- Switch on the ADF by pressing the button labelled («УПРАВ. АРК»).



- Set the "TLF - TLG" switch to the "TLF" position; this should produce a noise through the telephone speaker, and small fluctuations in the indicator arrow. Full operation of the radio compass should begin 1 - 2 minutes after its activation;



- Set the "Homing Near - Far" switch to the "Far" position, and the "ADF Channels" switch to the required channel;



- Set the mode switch to "Ant.," and the volume control fully to the right. The callsign of the long-distance radio station should be heard in the phones. The signal level should change on turning the volume regulator;



- Set the "TLF-TLG" switch to the "TLG" position, and the mode switch to "Comp.";



- The pointer bar must point to the long-distance radio station with an accuracy of $\pm 5^\circ$;



- Set the "Homing Near - Far" switch to the "Far" position, and the "ARC Channels" switch to the required channel;



- Press the "Frame" button and move the pointer arrow to 160 °. When the button is released, the pointer arrow should return to its previous position at a speed of at least 30 deg / s;



- Set the "RC - Off" switch on the intercom switchboard to the "Off" position.



Preparation for Taxiing

Before taxiing, look around:

- Rear left: are there any obstacles at the tail of the craft?
- Left: are any other aircraft in the process of taxiing?
- Ahead left and ahead right: are there any obstacles and/or personnel in front of the aircraft?

Perform the same for the right side.

Operational Procedure

- Request permission for taxiing. Upon receiving, reduce engine speed to minimum and signal the ground crew to remove the landing gear pads. Wait for the ground crew to signal that the pads have been cleared.
- Shut the canopy.
- At subzero temperatures switch on the circuit breakers for the stall detector heating and pitot heating. Check if the signal lights are on for these components, then begin taxiing.
- Circuit breakers must be turned while on the ground no more than 5 minutes before takeoff.
- Gradually increase the engine speed so that the aircraft begins to move without changing heading. Taxiing speed should not exceed that of a human's pace.
- While taxiing, keep the control stick fixed to neutral and use the brakes smoothly, pressing the brake control lever with short impulses when the rudder pedals are at neutral. When taxiing, the aircraft has a slight tendency to turn right, which is easily controlled by depressing the left pedal and applying brake pressure. In the case of a strong lateral wind (8 - 10 m/s), during taxiing, the control stick should be pushed down: this puts a greater load on the front wheel, causing the aircraft to steer more steadily.
- When performing long taxiing at low engine speeds, watch the onboard electrical consumers (ADF, compass, HSI). When the taxi is expected to be short, the engine RPM must ensure normal operation of the generator.
- Taxi to the pre-start line, mark a takeoff reference point, look at the left and right sides (checking if other aircraft are also taxiing to the pre-start line).
- Having routed to the runway, taxi on along the runway about 10 - 15 m in order to align the front wheel to the takeoff line. Then reduce the engine speed to minimum and bring the aircraft to a complete stop.
- Switch on the GDI on the compass control panel and set the takeoff course according to the UGR-4UK indicator.
- Keeping brake pressure on, check the following:
 - Cross-reference the readings on the magnetic compass with the readings on the UGR-4UK takeoff course of the strip; this should match the runway takeoff heading;
 - Check the correctness of the readings on the artificial horizon and the radio compass;

- Check if the propeller pitch control lever is set to the fine pitch position. During winter, set the engine RPM to 70% and switch the propeller pitch from fine pitch to coarse and back 2 - 3 times. This is done to warm up the oil in the propeller cylinders;
- Check whether the elevator trimmer is turned fully towards the pilot;
- Make sure that the landing flaps are retracted,
- At subzero temperatures in the carburettor inlet, takeoff is permitted ONLY with the air heater switched on.
- Once more check if there are any obstacles or other aircraft on the runway, taxiway and landing lanes. Check whether there are airborne craft that are on the go-around, or are on final for landing below an altitude of 50 m. Then, while holding the control stick and the rudder pedals in the neutral position, depress the brake lever, increase the engine speed to 54 - 57%, and request takeoff permission by radio.
- Having received permission, slightly add power and hold the plane on brakes.

The readings of the instruments should be as follows:

- The temperature of the cylinder heads should be between 120 and 220°C;
- The oil pressure should be around 4 - 6 kg_F / cm²;
- The oil temperature at the outlet should be between 40 and 75°C;
- The gasoline pressure should be around 0.2 - 0.5 kg_F / cm².

If the instrument readings exceed the specified limits, takeoff is strictly prohibited.

- Once again, briefly examine your surroundings, i.e. the landing and takeoff strip, then begin takeoff.

FLIGHT OPERATIONS



PHYSICS OF FLIGHT

In order to successfully pilot the aircraft and perform various aerobatic maneuvers, the pilot must have an idea of the physical basis of aircraft flight. A clear understanding of the forces operating on the aircraft is the foundation of correct maneuver execution during flight.

On Takeoff

Rollout

Acceleration to liftoff speed during the takeoff roll takes place under the influence of the difference in the thrust (acting in the direction of the aircraft's motion), the frictional forces of the wheels, and the drag force acting in the opposite direction of the motion.

- The undercarriage wheels' frictional force F_{TP} is dependent on the surface condition of the runway and the weight of the aircraft. Soft terrain will significantly increase the friction and length of the takeoff run. During takeoff however, the frictional force will gradually decrease as the pressure of the wheels on the ground will be reduced by the aircraft's gain in speed: $(G - Y)$. Take this into account when performing off-runway takeoff and landing.
- The greater the traction force, the greater the excess thrust $\Delta P = P - (F_{\text{TP}} + Q)$, and consequently, the greater the acceleration. Ergo to reduce the length of the takeoff roll, the engine must be driven to full speed.
- When the front undercarriage wheel is raised, the pilot creates the optimal angle of attack for liftoff, while creating a pitch-up moment that is balanced by the dive moment. With the increase in speed due to increased efficiency of the elevator, the pitch-up moment ($M_{\text{каб}}$) rises. The pilot must, until the moment of liftoff, maintain the angle of attack by keeping the front gear raised.

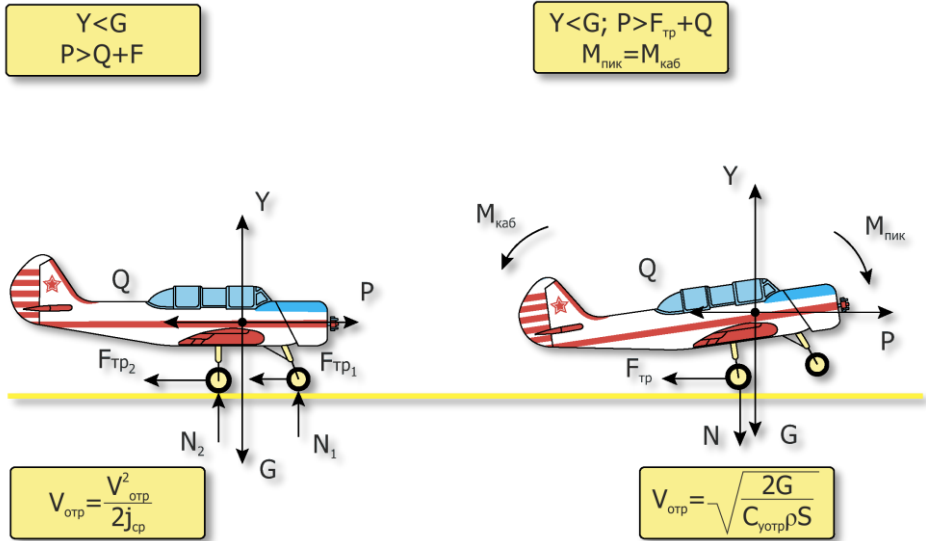

Figure 17. Forces acting on the aircraft during the takeoff roll.

Liftoff and acceleration

- Aircraft liftoff is caused by the difference between the lifting force and the weight force: $(Y - G)$.
- After liftoff, the aircraft should be accelerated with a gradual ascent from the ground to achieve the altitude and speed required for a safe transition to climb.
- Until the turn on the crosswind leg, the pilot must maintain a constant angle of climb in order to maintain the balance of forces: $P = Q + G_2; Y = G$.

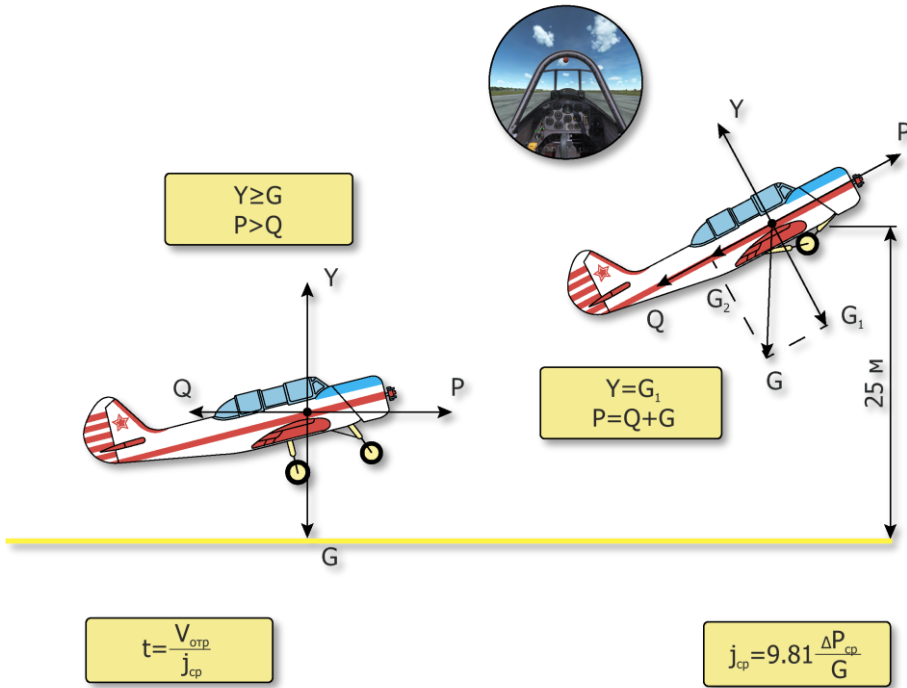

Figure 18. Forces acting on the aircraft during liftoff.

During Landing

Flare-out

To maneuver the aircraft from the gliding angle, the pilot must increase the wing angle of attack by deflecting the elevator. This increases the lifting force, which becomes greater than the component of the force of weight G_1 ($Y > G_1$) and warping the path of motion. The weight force component G_2 decreases, the drag component Q decreases, the drag component Q increases. As a result, $Q > G_2 + P$ the aircraft's airspeed decreases continuously.

Flare-up

Because airspeed decreases during flare-up, the rapid drop in lift needs to be compensated for by an increase in the angle of attack $\alpha(C_{y_0})$.

To this end, the pilot must maintain elevator deflection by pulling back on the stick, gradually bringing the aircraft to the ground for a soft touchdown on the two main wheels.

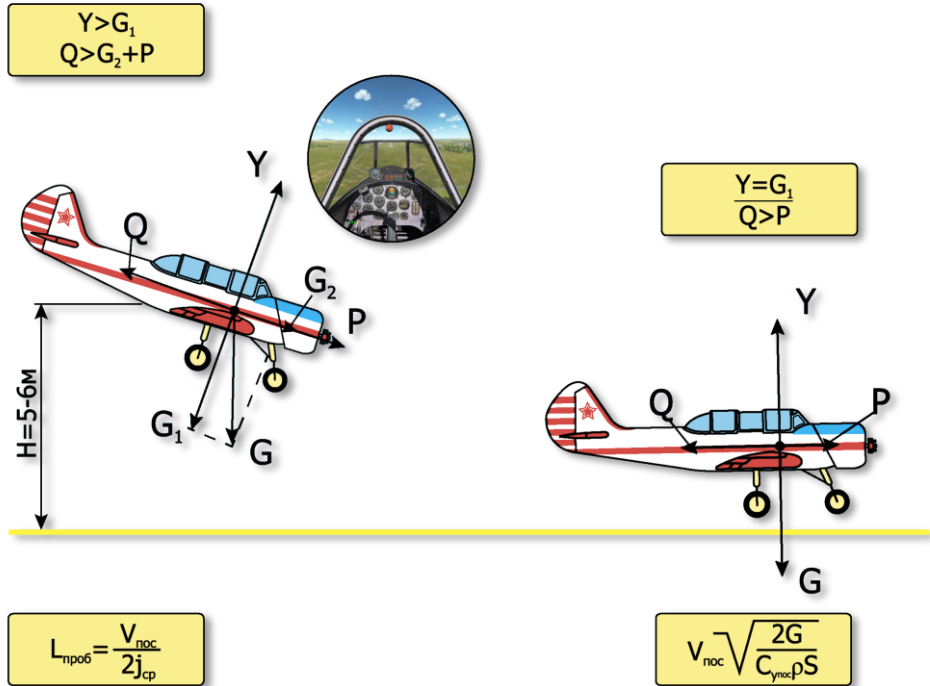

Figure 19. Forces acting on the aircraft during flare-out and flare-up.

Touchdown and landing roll first half

With a soft landing on the two main wheels in the first half of the run $M_{\text{каб}} = M_{\text{пик}}$.

With a decrease in speed during the landing run, the effectiveness of the horizontal tailfins decreases. Consequently, $M_{\text{каб}}$ decreases, leading to a decrease in $M_{\text{каб}}$. The plane then smoothly descends on the front wheel.

Landing roll second half

After the front wheel is lowered, the stick is set to neutral and the pilot begins to apply brake pressure. As the speed decreases, the lifting force falls and the ground contact force increases. This increases the frictional force of the wheels and increases reverse acceleration $j = 9,81 \cdot \frac{\Delta Q}{G}$. The speed of the aircraft is dampened greatly.

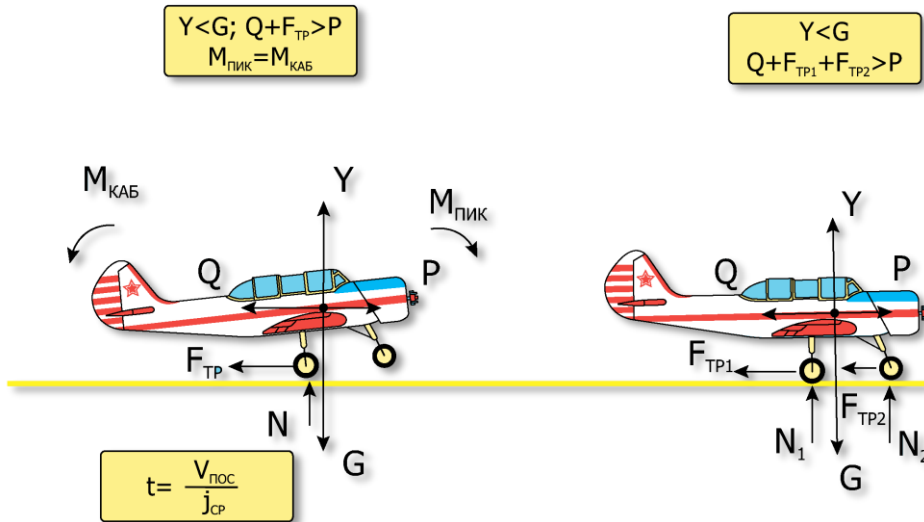

Figure 20. Forces acting on the aircraft during the landing roll.

In a Banking Turn

Conditions of a banking turn

- $Y_1 = G$ – constant altitude condition;
- $P = Q$ – constant speed condition;
- $Y_2 = const$ – constant radius condition.

On entry into the roll, the pilot rolls the aircraft to the required angle of bank. With the creation of the bank angle the lift component Y_1 balances the weight of the aircraft G . The other lift component Y_2 creates a curvilinear motion on the horizontal plane (shown in the diagram of forces).

To fulfil the conditions of a 360 deg. banking turn, the pilot must pull back on the stick to increase the angle of attack and lift force such that they balance the weight of the aircraft and maintain its altitude. At the same time, the lift component Y_2 increases and with it, the rotational rate.

An increase in the angle of attack is accompanied by a corresponding increase in drag Q . Therefore, the pilot must accordingly increase engine thrust so as to maintain the constancy of the forward speed.

At the end of the banking there will be an equilibrium of forces acting on the aircraft, i.e. $Y_1 = G$; $P = Q$, but an unbalanced force Y_2 will warp the trajectory of motion.

$$V_B = V_{r.n.} \sqrt{n_y},$$

where V_B – turn speed;
 $V_{r.n.}$ – level flight speed;
 n_y – G-load on turn.

$$n_y = \frac{1}{\cos(\gamma)},$$

where γ – bank angle on turn;
 P_B – thrust on turn.

$$P_B = P_{r.n.} \cdot n_y,$$

where $P_{r.n.}$ – thrust on level flight;
 r_b – turn radius.

$$r_b = \frac{V_B^2}{g \cdot \text{tg}(\gamma)},$$

t_b – time to execute.

$$t_b = 0,64 \cdot \frac{V_B}{\text{tg}(\gamma)},$$

Y_1 – lift component;
 Y_2 – lift component;
 Q – drag component.

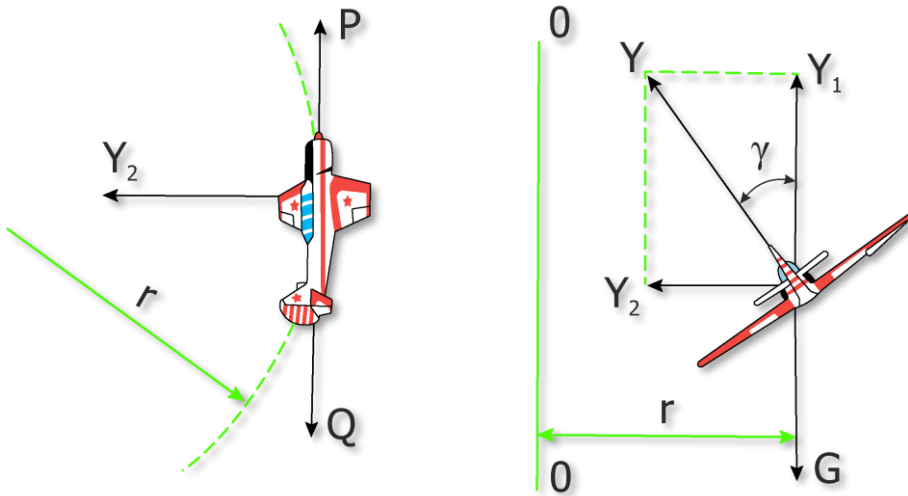

Figure 21. Forces acting on the aircraft during a banking turn.

Dive

Stages of a dive:

- AB – Pull-down;
- BC – Dive linear segment;
- CD – Dive recovery.

Pull-down

When entering into a dive from level flight, the lift of the aircraft is the distorting force, which decreases when the control stick is pushed down. The G-load will be negative. Pushing the stick down creates $F_{n.c.} = Y - G$, due to which the flight trajectory of the aircraft will be curved downwards.

Linear segment

$Y = G_1$ (provided that $\theta = const$). $P + G_2 > Q$ (positive acceleration condition).

As the speed increases, the angle of attack must be reduced to ensure that $\theta = const$. Otherwise, an increase in speed will lead to an increase in lift, and the aircraft has a tendency to reduce the dive angle.

Dive recovery

$$Y > G_1; F_{\text{н.с.}} = Y - G_1 \text{ (G-load } n > 1). P + G_2 \neq Q.$$

The loss of height from the dive is determined by the speed and angle of the dive, and also by the G-load created by the pilot in the recovery. This is determined by the formula

$$\Delta H = \frac{V_{\text{cp}}^2(1 - \cos(\theta_{\text{ВНК}}))}{k(n_{y_{\text{cp}}} - \cos(\frac{\theta_{\text{ВНК}}}{2}))}$$

Where V_{cp} m/s; $n_{y_{\text{cp}}}$ – mean value of true airspeed and G-load.

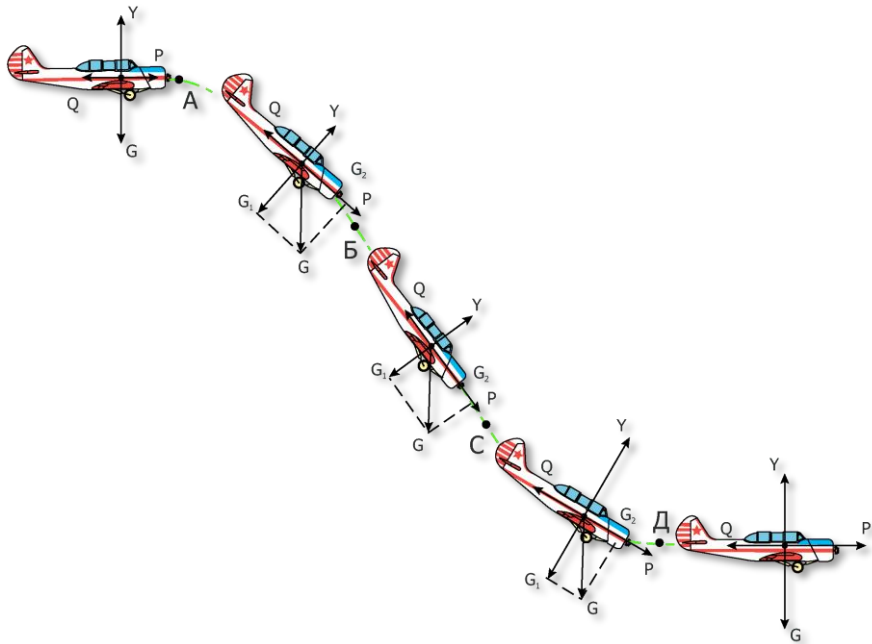

Figure 22. Forces acting on the aircraft during a dive.

Zoom

Stages of a zoom:

- AB – Entry to zoom;
- BC – Zoom linear segment;
- CD – Departure from zoom.

Entry

$$Y > G_1; F_{u.c.} = Y - G_1; n = \frac{Y}{G}; n > 1,$$

Where Y – lift;
 $F_{u.c.}$ – centripetal force;
 $Q + G_2 > P$ (aircraft speed falls during entry).

The angle of attack must be reduced by deflecting the control stick slightly forward in order to reduce the lift at the end of the aircraft's entry into the zoom.

Linear segment

$Y = G_1$ (constant climb angle condition);

$Q + G_2 > P$ (speed reduction condition).

As speed decreases, the lifting force decreases. To ensure that $Y = G_1$, the angle of attack must be increased.

Zoom Departure

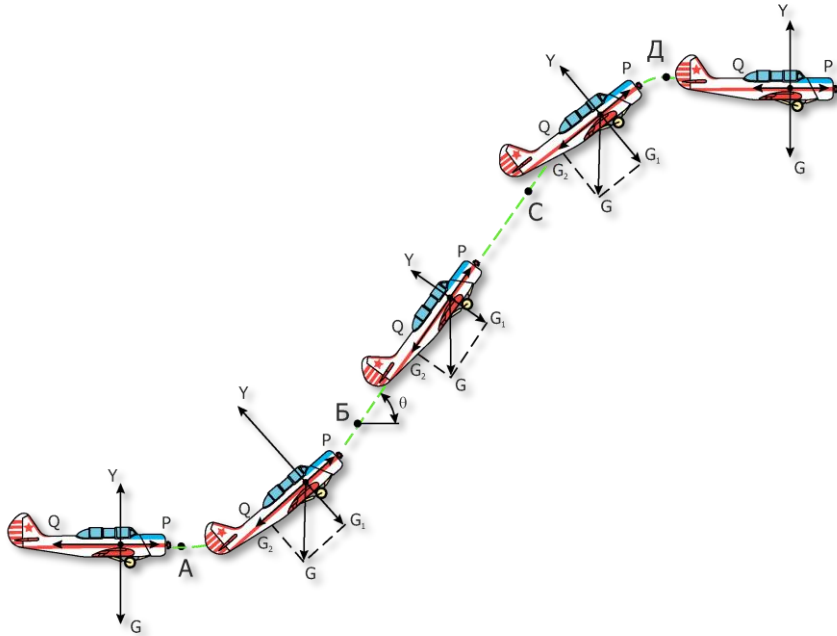

Figure 23. Forces acting on the aircraft during a vertical climb.

To avoid the occurrence of large negative G-loads, departure from the zoom must be performed with smooth movements of the control stick away from the pilot. The centripetal force curving the trajectory of the aircraft downward is determined by the difference between the weight of the aircraft and its lifting force:

$$F_{u.c.} = Y - G_1.$$

Hook Turn

When performing a hook turn, the pilot must flip the aircraft 180 ° with a maximum amount of climb in minimal time.

1. To this end, angle of attack and roll during the turn-in must be increased gradually, while the lift component Y_1 will exceed the weight force G . The other lift component Y_2 bends the trajectory of motion.

At a turn angle of $100 - 130^\circ$, both roll and climb angle should be reduced in order to prevent a loss of speed during the departure.

- At the end of the second third of the hook turn, the angle of attack must be reduced. The lift component Y_1 also decreases, which in turn causes a reduction in the climb angle and the weight component of the aircraft G_1 . The difference between the forces $Q + G_2$ and the thrust force P decreases, while airspeed decreases to a lesser extent.
- When departing from the hook turn, when the pilot reduces the angle of attack and roll by deflecting the stick and pedals, the lift components Y_1 and Y_2 decrease, and the weight component G_1 increases. Because of the difference in forces $Y_1 - G_1$ the trajectory in the vertical plane bends and causes a further decrease in the climb angle. Owing to a complete reduction in the component Y_2 the aircraft ends its turn.

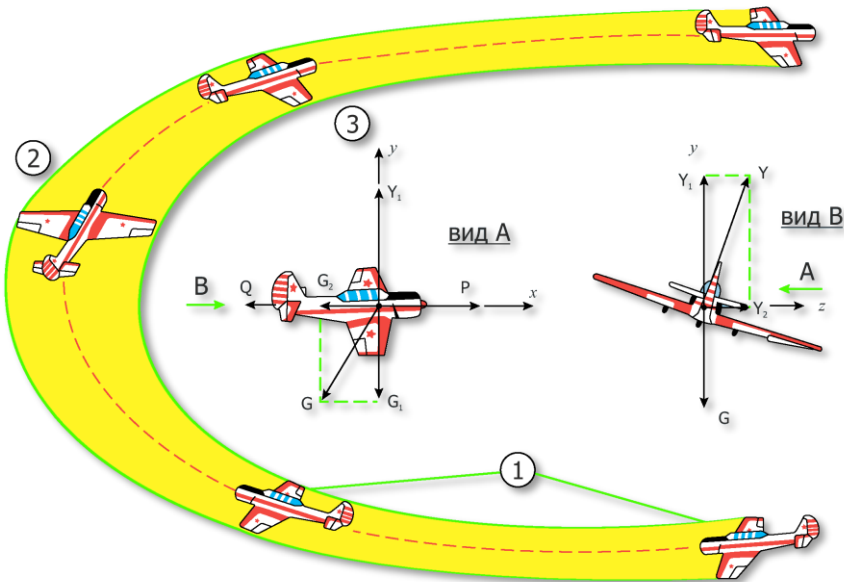

Figure 24. Forces acting on the aircraft during the hook turn.

During a Vertical (Nesterov's) Loop

At the beginning of the loop entry, the stick should be pulled smoothly in order to avoid a loss of speed in the apex of the loop, as an increase in the angle of attack leads to an increase of the lift and drag forces. Under the action of the curving force ($Y - G_1$ - difference between the lift force and weight force component) the aircraft moves along a curvilinear trajectory. On the ascending part of the trajectory the thrust force P is less than the sum of the drag force and weight force component $Q - G_2$. This is why airspeed continuously decreases.

The tempo of stick movement in the ascending part of the loop path should be such that the indicated airspeed at the apex will not be less than 140 km/h.

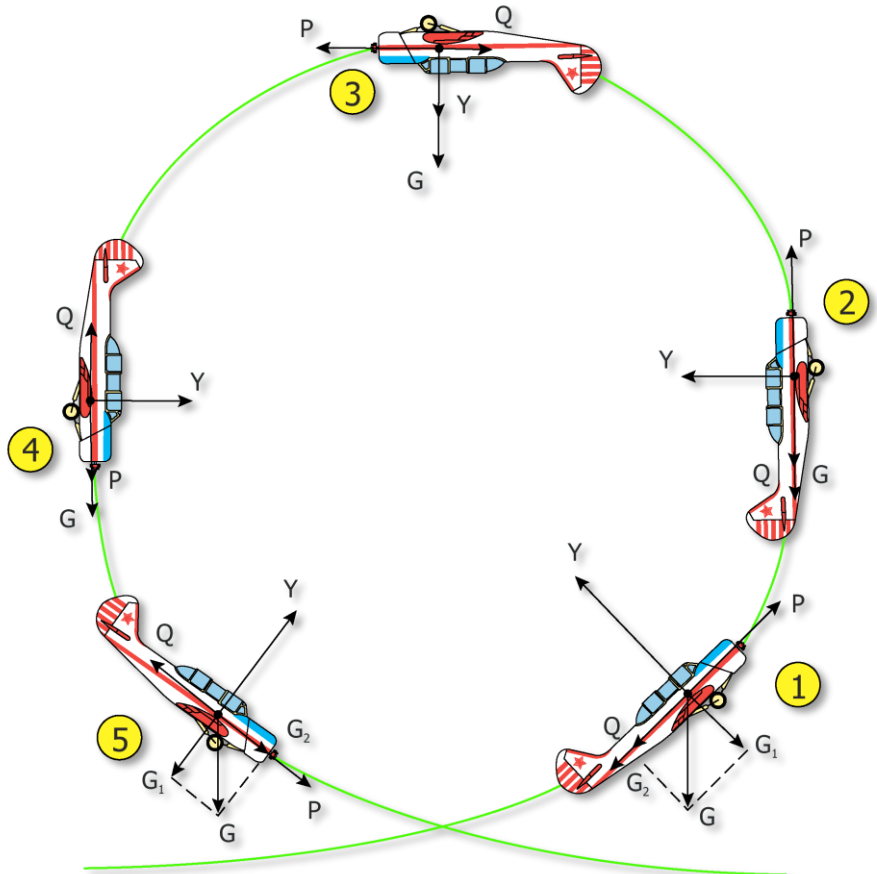

Figure 25. Forces acting on the aircraft during the loop maneuver.

Since the weight force and the lifting force while in the inverted position are directed in one direction, the aircraft easily goes into a dive. The bending force is determined by the lifting force and the weight force component perpendicular to the trajectory $Y + G_1$. Under the influence of the difference in the forces of the weight force component along the trajectory G_2 and the drag force Q the aircraft quickly gains speed.

The difference between the lift force Y and the weight component G is the bending force, under the influence of which the aircraft recovers from the dive. The pilot must pull on the stick with the correct

tempo such that the aircraft does not gain too high an angle of attack that would cause buffeting, and such that the aircraft's airspeed does not go too high (leading to a sharp decrease in altitude) when recovering from the dive.

CIRCULAR FLIGHT

BEFORE flight, the pilot (cadet) is required to:

- Study the layout of the airfield and its surrounding areas;
- Learn their aircraft's operating procedures, as well as the operating procedures for the aircraft's engines and cockpit equipment;
- Study the aircraft's flight characteristics;
- Learn the rules and techniques of performing a circular flight, and memorize the position of the frontal parts of the aircraft relative to the horizon while in the main flight modes;
- Be familiar with the location of the cockpit instruments and equipment, the procedure for handling equipment, as well as with the procedures for working with said equipment;
- Exercise good visuospatial attention and be well-versed in in-flight safety procedures necessary for performing circular flights;
- Learn the protocols for radio communications during flights in airspace surrounding the airfield.

WHILE in flight, the pilot is required to:

- Consciously train themselves to observe strict compliance of in-flight procedures;
- Carefully prepare for each flight, review past flights, and consciously correct past mistakes and errors;
- Correctly assess the air situation and meteorological conditions before each flight, and exercise good visuospatial awareness at all times while in the air;
- Know the proper procedures for dealing with abnormal operating situations;
- Be able to correctly analyse their own errors committed while in-flight, and independently draw conclusions on the measures that must be taken to prevent and/or correct them;
- Learn to seamlessly perform all of the procedures required for the safe execution of a circular flight, keeping in mind that takeoff and landing are always some of the most complex elements of any flight.

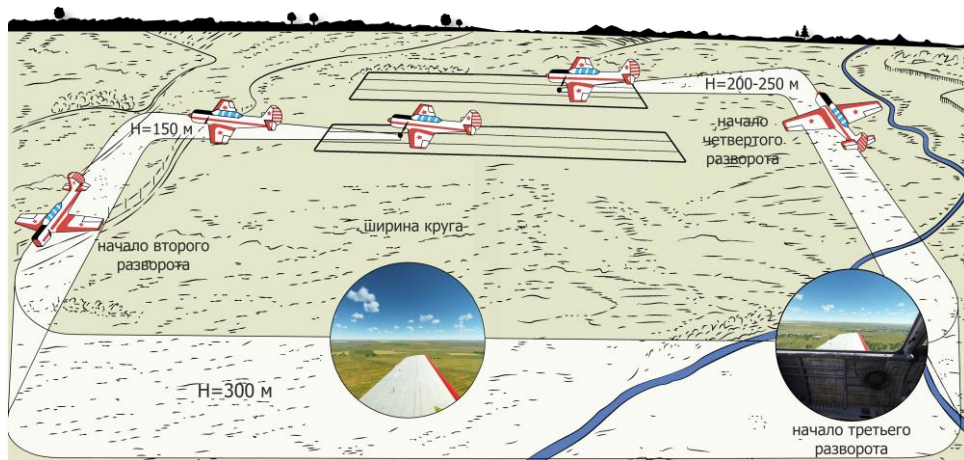

Figure 26. Circling procedure.

Takeoff and Climb

Procedure:

- Request for takeoff permission from flight control. Release the brake control lever, gradually increase engine speed, all while avoiding any change in the chosen aircraft heading for takeoff. Begin takeoff ground roll, keeping the control stick in the neutral position. Bring the engine speed to full. Note that the aircraft has a tendency to turn to the right during takeoff; this is mitigated by deflecting the rudder to the left.
- After reaching a speed of 90 km/h, smoothly pull up on the stick, raising the front wheel to the takeoff position.
- The aircraft's liftoff speed is 120 km/h.
- On liftoff, shift your view to the ground left of the aircraft's longitudinal axis by 25 - 30° and forward by 25 - 30 m, monitoring the aircraft's altitude and direction. Take care not to lose direction, and avoid banking the aircraft.
- Hold the aircraft above ground up until reaching 160 km/h. Upon reaching 160 km/h, smoothly transfer the aircraft into a climb.
- Retract the undercarriage at an altitude of no less than 20 m. Watch the undercarriage status when retracting using the dashboard warning lights and mechanical indicators. After this, set the engine operating mode to the following parameters:
 - Reduce pressurization by 25 - 30 mmHg.
 - Set the engine RPM to 82% using the propeller pitch lever.

- When climbing at a speed of 170 km/h, the horizon should pass around the base of the front cockpit windshield. Watch your speed!
- Set the elevator trim to reduce load on the control stick.
- Check the following readings on your instruments:
 - Cylinder head temperature: 140 - 190° C;
 - Oil temperature at the engine inlet: 50 - 65° C;
 - Oil pressure: 4 - 6 kg/cm²;
 - Gasoline pressure: 0.2 - 0.5 kg_f/cm².
 - Maintain a speed of 170 km/h.
- Maintain a speed of 170 km/h.
- After monitoring the instrument readings, look the following directions:
 - Ahead left: Determine whether there are aircraft in the surrounding airspace and whether they risk interfering with your flight plan, whether your current heading is safe; quickly identify the location of potential landing areas in case of forced landing;
 - Hard left (down and up): Check to see if there are other aircraft nearby.
 - Do the same for ahead right and hard right. Is the flight direction with respect to the landing signs intact? Are there any aircraft on the go-around?

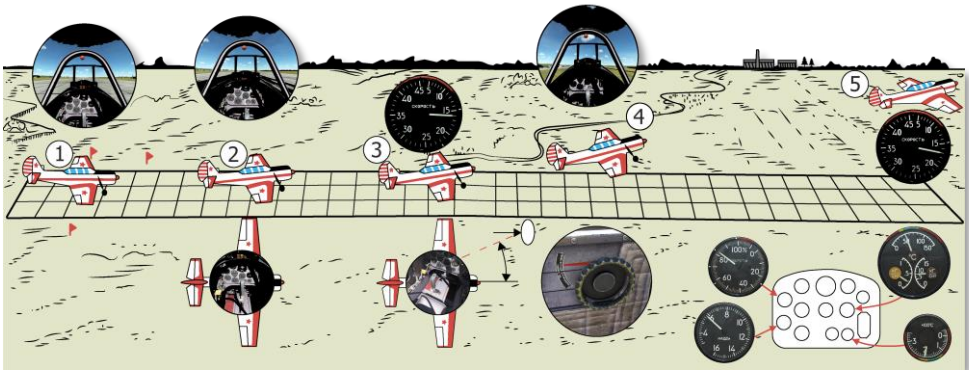

Figure 27. Takeoff procedure.

Turns on Crosswind and Downwind Leg

Turn on crosswind leg

Procedure:

At an altitude of 130 - 150 m, look around:

Ahead left - are there any aircraft preventing your turn?

Choose an emergency landing site.

Check rear left, hard left, ahead left to cross-reference the position of the nose relative to the horizon, your current direction, and roll angle. Do the same for the right side. After your look-around, make a mental mark on a point at an angle of 90° relative to your direction of flight for the crosswind rollout turn.

At an altitude of 150 m, check your speed, which should be at around 170 km/h. With smooth, coordinated movements of the control stick and pedals, bring the plane to a turn.

When the roll reaches the set value (30°), use slight movements of the pedal opposite to the direction of the roll to eliminate the aircraft's tendency to increase the angular rotation. Move the stick to the side opposite of the turn to maintain the given roll angle.

In your sustained turn, pay attention to the following:

- Position of the nose relative to the horizon;
- Angle of roll and pitch;
- Steady speed of 170 km/h;
- Position of the ball in the center of the DA-30 slip indicator.

Exit from the turn starts at $20 - 25^\circ$ to the previously noted landmark at a speed of 170 km/h. To maintain speed when pulling out of the turn, slightly push on the throttle.

Set nose position relative to horizon as in during a climb. Check the speed, which should still be 170 km/h, and look around. Once more identify landing spots in case of an emergency landing.

Turn on downwind leg

This turn begins at the moment when the angle between the longitudinal axis of the aircraft and the line of sight to the air-tee is 45° .

The second turn in the climb is performed at a speed of 170 km/h, and in horizontal flight - at a speed of 180 km/h.

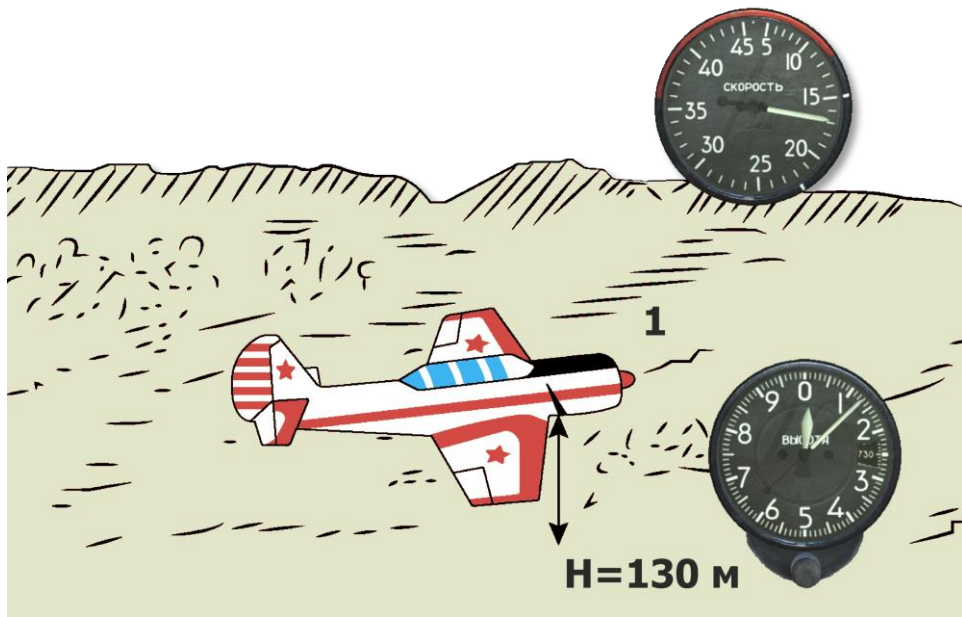

Figure 28. **Preparation for crosswind leg turn.**

After gaining an altitude of 300 m, gently push on the control stick and bring the aircraft into horizontal flight, reducing the pressure to 470 - 490 mmHg and setting a speed of 180 km/h and an RPM of 70%.

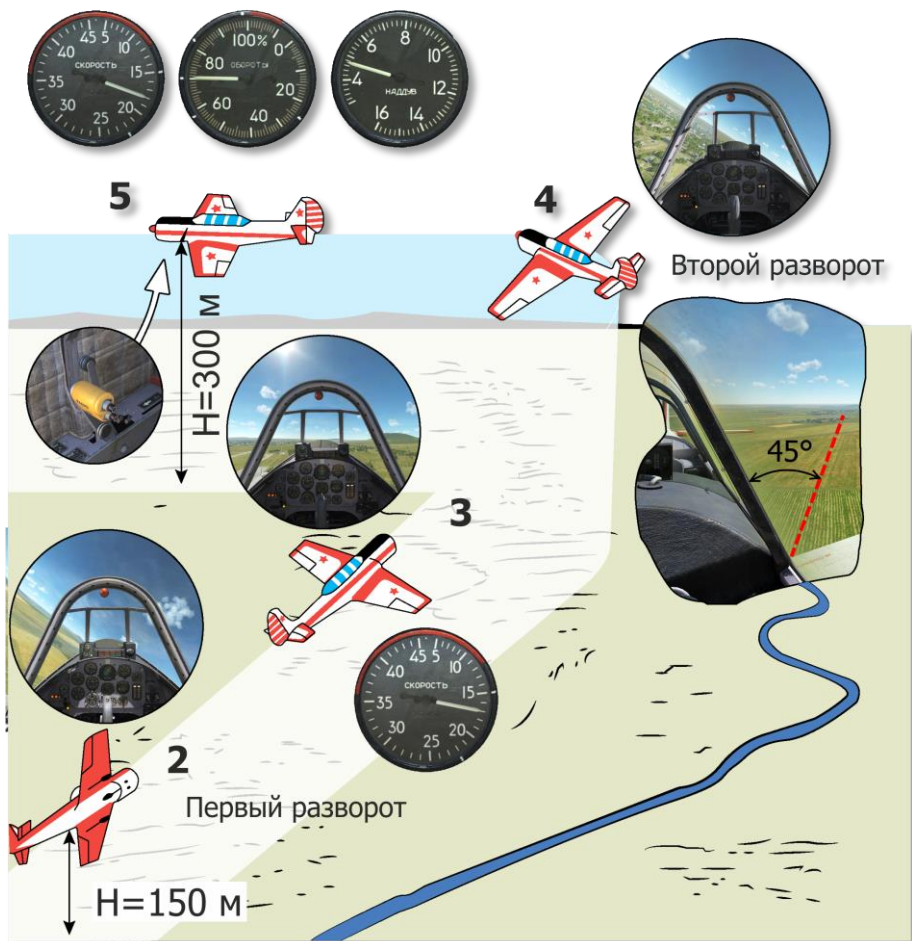

Figure 29. Flight scheme for both turns.

Turn on Base Leg from Downwind Leg

The exit from the downwind leg turn and the transition flight to the base leg turn must be parallel to the line of the landing marks. The compass heading must be equal to the reverse runway heading. Speed must be 180 km/h, pressure at 470 - 490 mmHg, RPM at 70%.

When transitioning between these two turns, control the width of the route and the parallelism of the flight path with respect to the landing marks. If the route is correctly constructed, the wing panel must pass along the line of the landing signs without obscuring them.

When examining the air space, remember that the nose should never obscure any aircraft flying ahead of you. It should always be in the field of view of the pilot: in a left-turn circuit, keep it on the left, and vice versa.

On the traverse of the air-tee, increase the pressure, deploy the undercarriage, as always monitoring the signal lights and mechanical indicators on the dashboard. Remove the load from the trim control knob, and request permission to land.

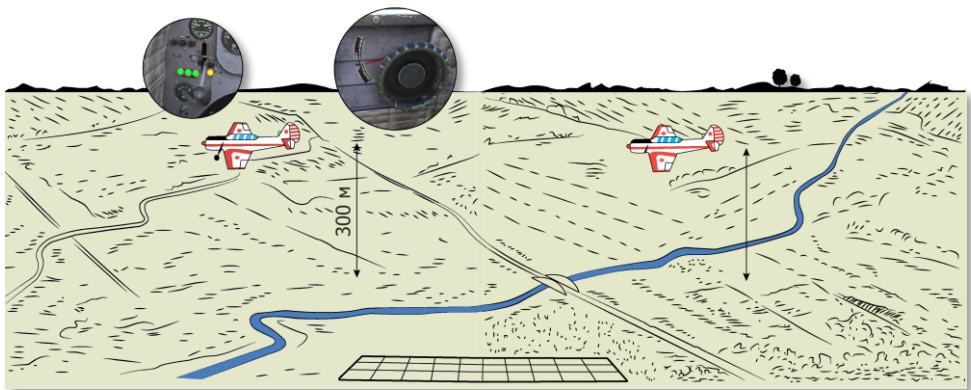

Figure 30. Transition to base leg turn from downwind leg turn.

Base Leg Turn

This phase begins when the angle between the longitudinal axis of the aircraft and the line of sight to the air-tee is 45° .

Before entering the turn, the engine RPM should be increased to the amount necessary to maintain a speed of 180 km/h; after exiting the turn, RPM must be reduced by the same amount.

After exiting the turn, the longitudinal axis of the aircraft should be directed at an angle of $70 - 80^\circ$ to the line of landing marks.

After exiting the third turn and while keeping the speed at 180 km/h, observe the surrounding airspace and account for all aircraft flying directly ahead, and do not lose sight of them until they land and clear the tarmac. Also be sure to watch the temperature of the engine.

As you approach the landing signs, determine the moment of transition to your landing glide. Switch to fine pitch. You should be reducing pressure when the landing signs project at an angle of $30 - 35^\circ$,

formed by the transverse axis of the aircraft and the line of sight to the landing T. Set the speed to 170 km/h.

As always, exercise good visuospatial awareness.

From the moment of transition to gliding to the beginning of your turn to final, your loss in altitude should be in between 50 - 100 m with a rate of descent within 4 - 5 m/s. Maintain this stable speed and glide angle.

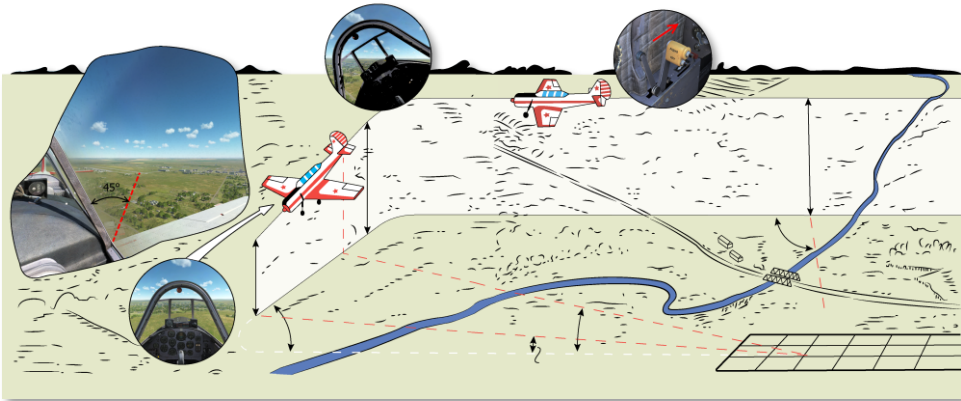

Figure 31. **Base leg turn.**

Turn to Final, and Follow-up Actions

The turn to final begins when the distance from the leading edge of the wing to the line of landing marks is approximately 0.5 m, and the angle between the line of landing marks and the pilot's line of sight is 15 - 18 °. The altitude of entry is 200 - 250 m.

The speed at this turn should be 170 km/h, and the roll angle - 30 °. Altitude of exit should be no less than 150 m.

After exiting this turn, set the glide angle to correspond to an airspeed of 160 km/h.

Check the following:

- Correct heading. Check for deviation; if any, eliminate with roll.
- Whether the undercarriage is deployed.
- Whether the runway is completely free of obstruction.
- Whether other planes are interfering with the landing. Look around, but pay special attention to the right side.

After confirming that there are no obstructions to your landing, deploy the landing flaps. Set and maintain a speed of 160 km/h and keep the aircraft from nosing up with small, smooth motions of the control stick.

If, during gliding, the "hazardous speed" or "stall" warning lights activate, with the accompanying audio warnings in your headset, immediately check your glide speed if it is less than 160 km/h at an altitude of less than 50 m, decrease the aircraft's angle of attack by pushing down on the stick, increase engine speed, and set the required speed.

If the aircraft is installed with a ski undercarriage, the pilot must press the brake handle 3 - 5 times during the glide phase (at an altitude of no less than 50 m) directly before landing.

Calculate your approach. With the correct calculation and a headwind of 4 - 5 m/s, the landing "T" should be projected in the middle of the windshield on the left side, and your glide path should be directed to the alignment point (100 - 120 m to the landing T).

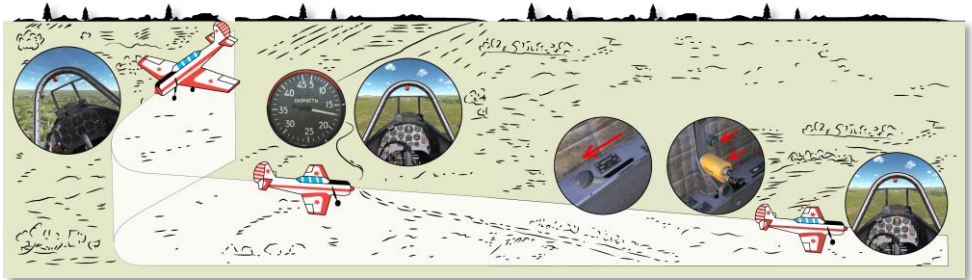

Figure 32. Turn to final.

Do not allow the cylinder temperature to fall below 150° C during gliding!

To correct the pull-up calculation, perform the following:

- Increase engine RPM;
- Reduce the glide angle to preserve the required glide speed.

Pulling can be carried out up to an altitude of 5 - 6 m with a speed of 160 km/h.

When it becomes necessary to pull up for an extended amount of time, perform it in the horizontal flight, maintaining a speed of 160 km/h. Do not throttle down prior to gliding, as the aircraft will lose speed and stall due to the sharp increase in vertical speed. Descents with reduced pressure should be finished before reaching an altitude of 50 m.

The sideslip method is used to correct the aircraft heading during landing. Before entry, first turn the nose of the aircraft 10 - 15 ° from the glide course to the side opposite of the slip and create a roll in the direction of the slip (but not more than 30 °). The airspeed should be 160 km/h and exit should be made at an altitude of not less than 50 m. At this altitude, the aircraft must again be in the glide. After ending the slip, immediately eliminate the drift with a short roll (5 - 10 °) in the direction opposite to the slip. On slip, the aircraft acquires descent inertia, and exiting the slip at an altitude of less than 50

m can lead to the aircraft making contact with the ground surface before even reaching the landing strip.

If the pilot is unable to make the necessary corrections before hitting 50 m altitude, a go-around is necessary.

Once more ensure that the landing strip is clear and that there is no drift; otherwise, eliminate the drift with roll. Ensure that the space to the right of the aircraft that landed prior has enough space for your landing. Double-check your glide angle and speed, and reassess your calculations (if you will be able to touch down successfully onto the tarmac.)

Go-around/Wave-off

The go-around/waving off procedure ideally should be performed at an altitude no lower than 50 m.

If the need arises, the pilot can wave off from any altitude. Gradually increase the engine RPM to full, and gently push the stick down to combat the aircraft's tendency to nose up. When the speed reaches 160 km/h, go into a climb. Retract the undercarriage, then the flaps, at an altitude of 70 - 80 m. Increase the speed to 170 km/h. Note that with an increase in engine speed, the airplane will turn to the right. Combat this with left rudder.

Landing

Pre-landing checklist

Check the following before you reach an altitude of 30 m:

- Correctness of your landing calculation;
- Airspeed, and absence of roll;
- Whether the approach to the landing T has been made accurately;
- Whether the cross is laid out; whether there are any obstacles in the way;
- Whether there are other aircraft in your flightpath;

If there are any obstacles to your landing, immediately wave off.

Never glide close to a second aircraft with the assumption that it will manage to clear the tarmac by the time you touch down. If this is the case, immediately wave off!

Flare-out

At an altitude of 30 m, make sure that the runway is free, check your speed, and look at the ground from the left side of the nose towards the start-point of your flare-out maneuver. Your view should be directed 20 - 25 ° to the left of the longitudinal axis of the aircraft and 25 - 30 m ahead.

At an altitude of 5 - 6 m, smoothly pull back on the stick and begin levelling at such a rate that you will be able to exit the glide angle at an altitude of 0.75 - 1 m. Simultaneously reduce engine RPM, which, at an altitude of 0.75 - 1 m should be reduced completely.

Flare-up

After the flare, check if your flare ended too high. The altitude should be no more than 0.75 - 1 m. At this altitude, the pilot must flare-up the aircraft to bleed speed before touchdown. Take note that after the end of the flare, with fully reduced pressure, the aircraft will quickly bleed speed, and so the flare-up time will be relatively short.

Landing

As the airplane descends to the ground from an altitude of 0.75 ... 1 m, maneuver the aircraft into the landing position with smooth and proportionate movements of the stick, in such a way that touchdown occurs at an altitude of 0.15 - 0.25 m, without roll, on the two main undercarriage wheels. The landing speed with flaps released should be 115 - 120 km/h.

Landing roll

After landing, when the aircraft lowers the nose wheel and begins to roll steadily, you can begin applying brake pressure.

Maintain the roll heading using the markers on the tarmac.

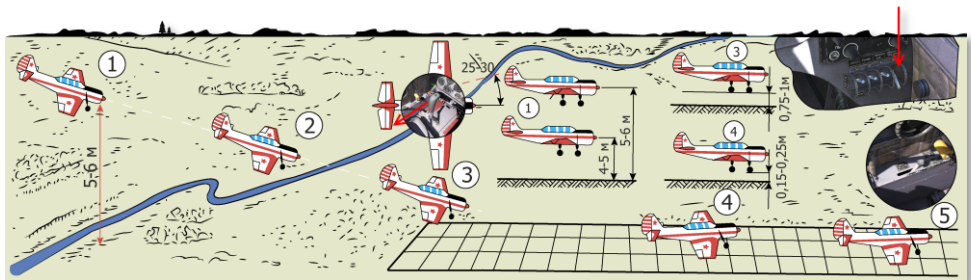

Figure 33. Landing procedure.

Post-landing taxiing

When taxiing, inspect the lane ahead and observe other aircraft in the process of landing, taking off, and taxiing. If there is an aircraft ahead of you taxiing in the taxiing lane, you must stop and give way. When taxiing, monitor the cylinder head temperature and the oil temperature.

Retract the landing flaps, turn off the circuit breakers for the pitot heating, aviation clock, and the stall warning system. Also shut off the radio compass to preserve battery power during extended taxiing procedures. Once more, your taxiing speed should not exceed the pace of a fast-moving person.

Engine shutdown

Before shutting down the engine, first shut off the radio, the radio compass, the aircraft intercom, and the artificial horizon. If necessary, cool down the engine.

To shut down the engine, perform the following:

- increase engine RPM to 65 - 68% over 20 - 30 seconds for a clean up of the igniters;
- throttle down to reduce the speed to 28 - 34%;
- turn off the magneto by setting the switch to the "0" position;
- smoothly push the throttle forward (to open the throttle valve of the carburettor);

After engine shutdown, pull the throttle all the way back, and shut off the fire cock once the aircraft is parked.

Turn off all other circuit breakers and switches on the switchboard.

COMMON MISTAKES DURING LANDING

Over-flaring

Causes

Over-flaring can be caused by the following:

- Incorrect view angle (pilot miscalculation due to looking too close to the wing or fuselage);
- Disproportionate stick movement during flaring;
- Pilot miscalculation or inability to determine aircraft distance from ground.

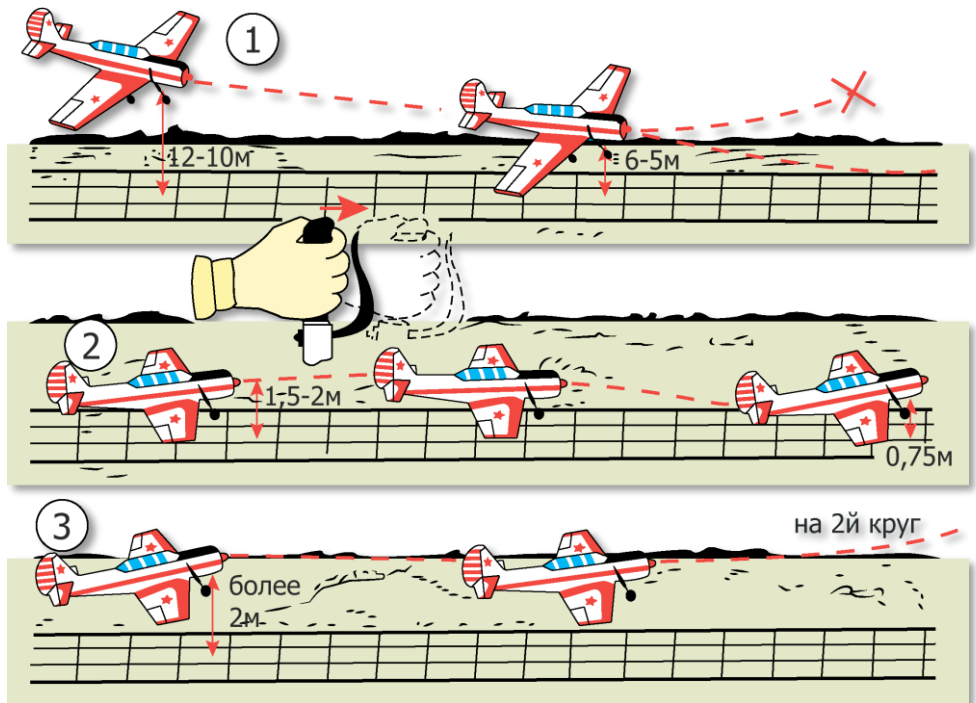

Figure 34. Errors during landing and corrective measures.

Corrective measures

1. If, during the flaring process, the pilot notices that he will finish at an altitude higher than 12 - 10 m, he must maintain stick movement in such a way that the aircraft will descend to an altitude of 6 - 5 m.
2. If flaring completes at an altitude of 1.5 - 2 m (high-speed flaring), the pilot must smoothly push the stick down, maneuvering the aircraft to an altitude of 0.75 - 1 m and touching down normally on the main undercarriage legs.
3. If the flare finishes at an altitude higher than 2 m, gently increase engine speed and, without taking your eyes off the ground, wave off and go around.

Ballooning

Causes

Common causes:

- Gliding at excessive speeds;
- Flare-out and flare-up at low altitudes;
- Late head-down transition;
- Incorrect view direction during flaring;
- Sharp and sudden stick movement.

Corrective measures

1. If the aircraft begins to gain distance from the ground during the first half of the flaring procedure, the pilot must smoothly push the stick down in order to lower the aircraft to an altitude of 0.75 - 1 m, and then pull back up to a degree proportionate to the aircraft's rate of descent to the ground - this lets the pilot touch down normally on the two main landing gears.
2. If the aircraft has soared up during the second half of the procedure, the stick must be held in its neutral position and then, as the aircraft begins to descend, pulled up in order to touch down on the main landing gears. The pilot however must take into account the greater vertical descent rate.

If the pilot fails to perform the above procedures and the aircraft rises by 2 m or more, the pilot must wave off, taking care not to lose sight of the ground.

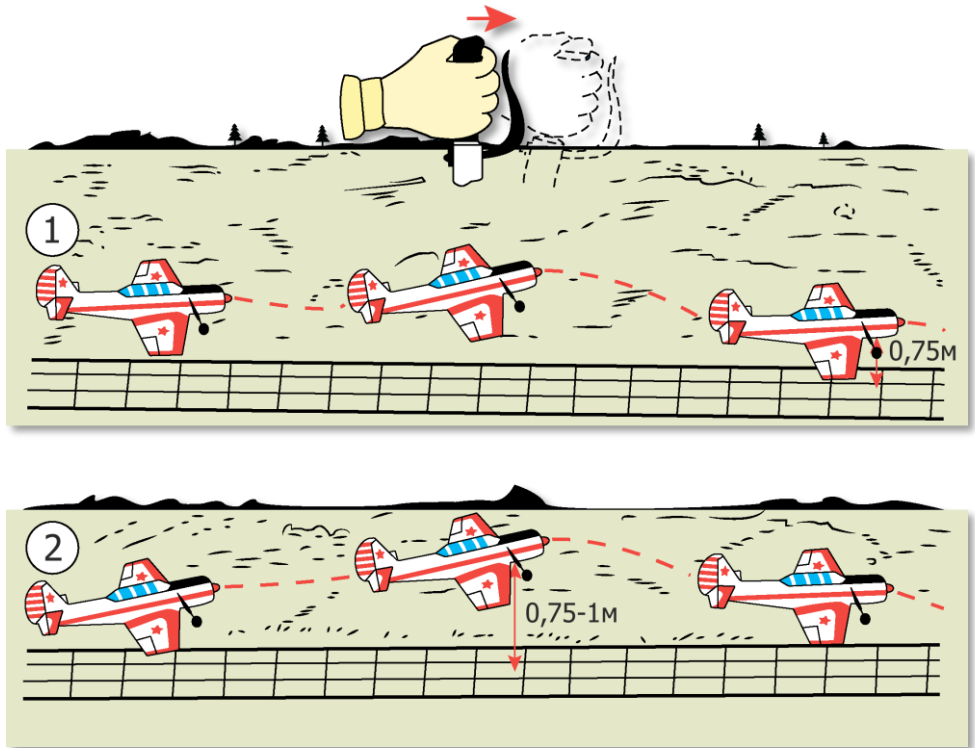

Figure 35. **Ballooning and corrective measures.**

Bounced Landings

Bounced landings can be high-speed and non-high-speed depending on the touchdown speed. When touching down on all three wheels or with a slightly raised front wheel, bouncing occurs when the pilot pulls back on the stick at the moment of touchdown.

High-speed bouncing

In this case, the pilot must, without taking his eyes off the ground, cease stick movement, and depending on the intensity of the bouncing on touchdown, push down on the stick to combat the aircraft's upward movement. Afterwards, the pilot must pull up to allow for aircraft touchdown on the two main undercarriage wheels.

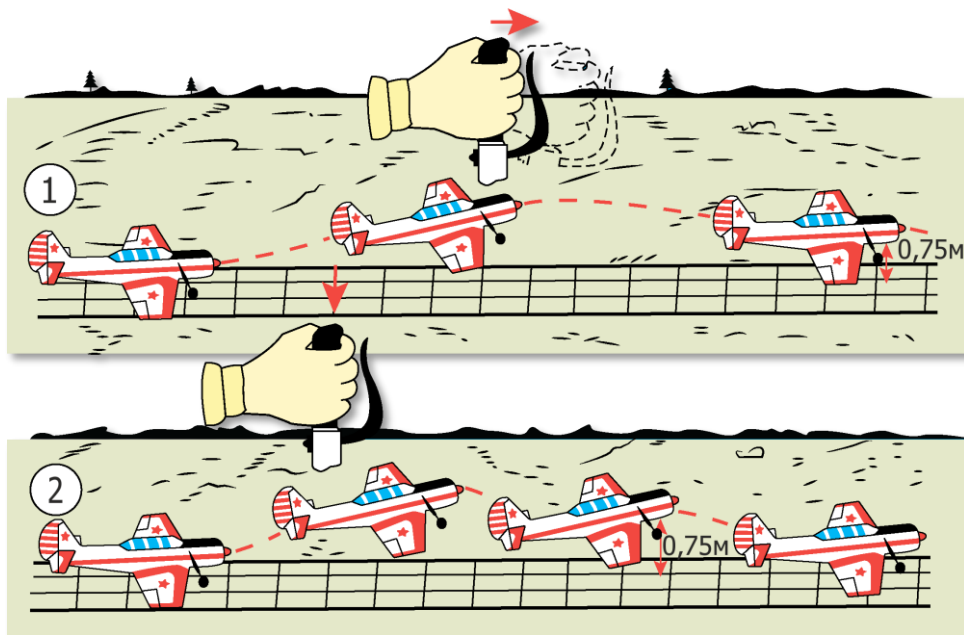

Figure 36. Bounced landings and corrective measures.

Non-high-speed bouncing

Occurs during the landing ground roll due to uneven terrain, or early and sharp lowering of the front wheel. In this case, the control stick is held in the position it was in at the moment of aircraft separation from the ground.

Under no circumstances must the pilot transfer control of the stick!

AEROBATICS

30° - 45° Rolling Circle

A rolling circle with an angle of 45 ° is performed at a speed of 190 km/h.

When entering the maneuver, pay attention to the following:

- Smooth application of bank and creation of angular velocity;
- The amount of bank (according to the position of the windshield and nose relative to the horizon, and according to the HSI);
- Altitude and flight speed retention (according to aircraft instruments) and rudder action.

When concluding the maneuver, pay attention to the following:

- Retention of the correct position of the windshield and nose relative to the horizon;
- Simultaneous decrease of roll and angular velocity;
- Altitude and speed retention (according to instrument readings);
- Coordinated rudder action;
- Exit in the direction of the intended landmark.

During the steady-rate turn, pay attention to the following:

- Retention of the correct position of the windshield and nose relative to the horizon;
- Retention of the set roll rate, constant angular velocity, speed and altitude (all according to instrument readings);
- Coordinated rudder action;
- Awareness of the surrounding airspace, especially in the direction of the turn;
- Exit vector.

Technique

Balance the aircraft using the elevator trimmers and set a speed of 190 km/h with 82% engine RPM.

Before entering the turn, define a reference point (landmark) in the direction of entry and exit.

At the same time, with smooth coordinated movements of the control stick and rudder pedals (with stick input coming first), bring the aircraft into the turn and increase engine RPM. Cross-reference the amount of roll using the position of the nose and visible parts of the aircraft windshield relative to the horizon and the readings on the HSI. After attaining the required amount of roll and angular velocity, the pilot must then combat the aircraft's tendency to roll further and spin up; slightly push down on the control stick and push down on the rudder pedal in the direction opposite of the roll itself and of the bank direction. The more energetic the aircraft's entry into the roll, the greater the required input on roll and yaw.

At 30 ° to the set reference point, begin exiting the roll with inputs on the control stick and rudder pedals (with rudder input coming first). Push down on the stick and maneuver the aircraft to horizontal flight.



Figure 37. 30°-45° Rolling circle

60° Rolling Circle

While still in level flight, balance the aircraft with the elevator trimmers at an airspeed of 210 km/h and engine RPM of 82%. Once again, set a reference point for entry and exit from the maneuver.

Procedure for entry into the roll is the same as was given above.

When aircraft roll begins to approach 60°, the control stick should be pulled slightly up, and the pilot must begin to relax rudder input. Hold the aircraft aligned with the horizon by means of yaw input in the direction opposite of the roll. With a roll of 45°, the rudders begin to operate in the opposite planes.

The amount of roll is determined and maintained by using the angle between the position of the aircraft canopy and hood relative to the horizon line, as well as the readings on the HSI.

Control stick inputs must be smooth and controlled; sudden sharp inputs may cause the aircraft to stall.

Exit from the roll must be done at 30 - 50° to the reference point.

With simultaneous inputs on the stick and pedals (but begin applying rudder input before stick input), reduce the aircraft's roll and angular rotation. During roll exit, reduce the engine RPM to its original value.

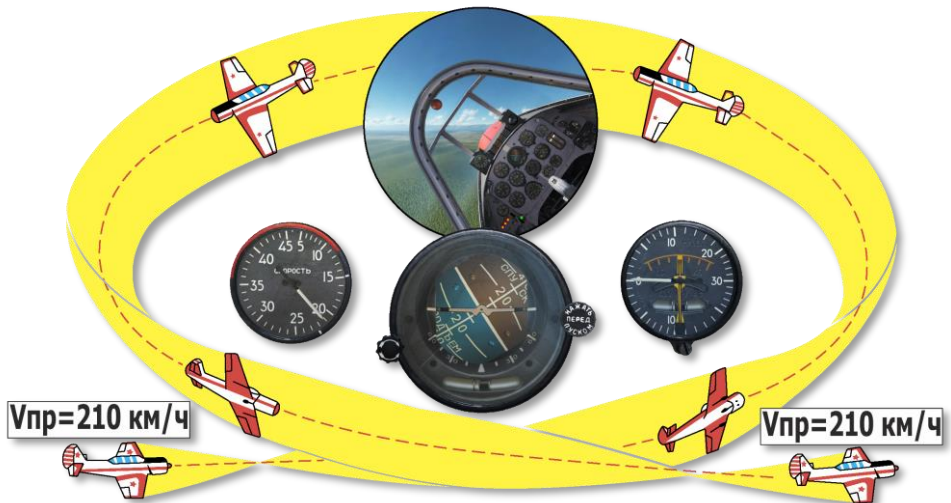

Figure 38. 60° Rolling circle.

Dive

Diving may be performed from any angle. For training purposes, it is performed with an angle of 30 - 45 °.

Pull-down

Balance the aircraft at a speed of 250 km/h during horizontal flight. Select a reference point for the dive course, set the speed to 140 km/h, and gently pitch down to maneuver the aircraft to the desired dive angle (30 ° or 45 °).

Ensure the following during the dive procedure:

- Angle constancy (the aircraft has a tendency to reduce the angle with an increase in the dive speed from pitching down);
- Speed increase;
- Dive direction.

Dive rollout

Exiting the dive should be done at a speed of no more than 250 km/h. With smooth motions of the control stick and without exceeding a G-load of +5, bring the aircraft back into horizontal flight.

During the dive rollout process, pay attention the following:

- Aircraft speed;
- Aircraft roll (counteract any roll with stick input in the opposite direction);
- Entry into the set reference point;
- G-load;
- Smooth increase of engine RPM (it is recommended to smoothly increase engine pressure to maximum over 2-3 seconds).

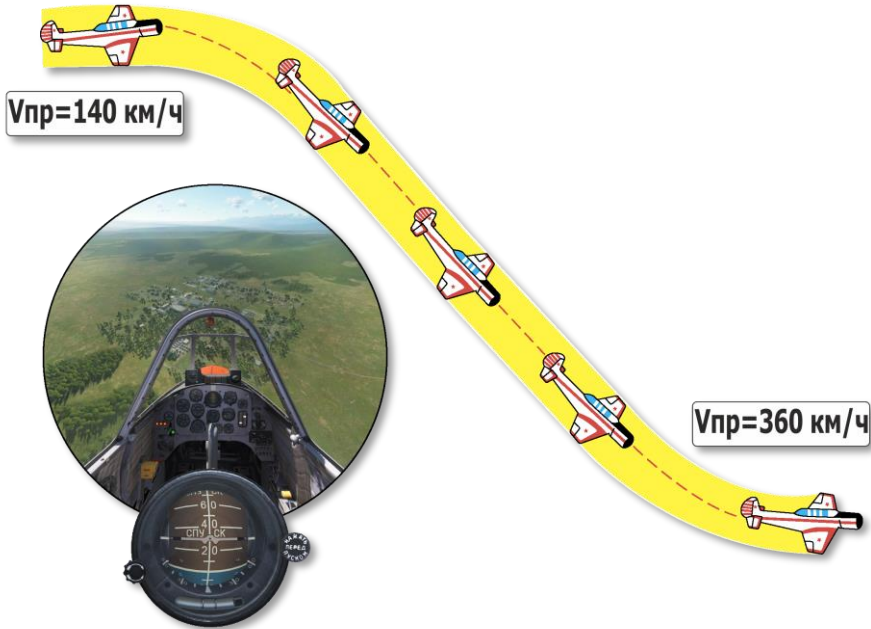

Figure 39. Dive maneuver.

Zoom

The zoom maneuver may be performed with any angle of ascent up to full vertical. For training purposes, it is performed at an angle of 30° .

Set the speed to at least 300 km/h at an RPM of 82% and with full supercharging. With a smooth but energetic pull of the control stick, maneuver the aircraft into a climb with an angle of ascent of $\theta = 30^\circ$ (towards the reference point). After reaching the predefined angle, the control stick must be pushed down in order to avoid a further increase of the climbing angle.

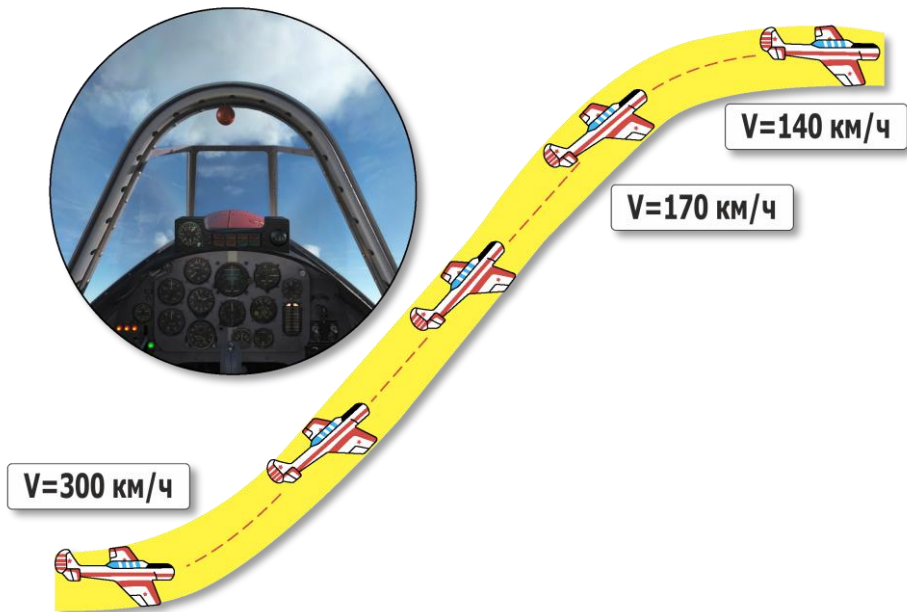

Figure 40. Zoom maneuver.

During the zoom, pay attention to the following:

- Angle constancy (using the HSI);
- Indicated airspeed;
- Lack of roll and slip;
- Moment of exit from the maneuver.

Upon reaching an airspeed of 170 km/h, begin to exit the maneuver back into horizontal flight with a smooth, coordinated push of the control stick.

Pay attention to the following when exiting the maneuver:

- Smoothness of the pitch-down motion. Sharp movements may cause the aircraft to enter a tailspin;
- Exit speed;
- Aircraft roll (combat by deflecting the control stick in the direction opposite of the roll).

Exit speed must not be lower than 140 km/h.

After exiting the maneuver, the pilot must reduce the engine RPM and reassess the aircraft's current position in the airspace.

Hook Turn

To perform a hook turn, increase the engine RPM to 82% while in horizontal flight and with full supercharge. Set airspeed to 300 km/h and define a reference point for entry and exit from the hook turn. With smooth but energetic rudder input bring the aircraft into the hook turn. The maximum roll of turn during the maneuver is 50 °.

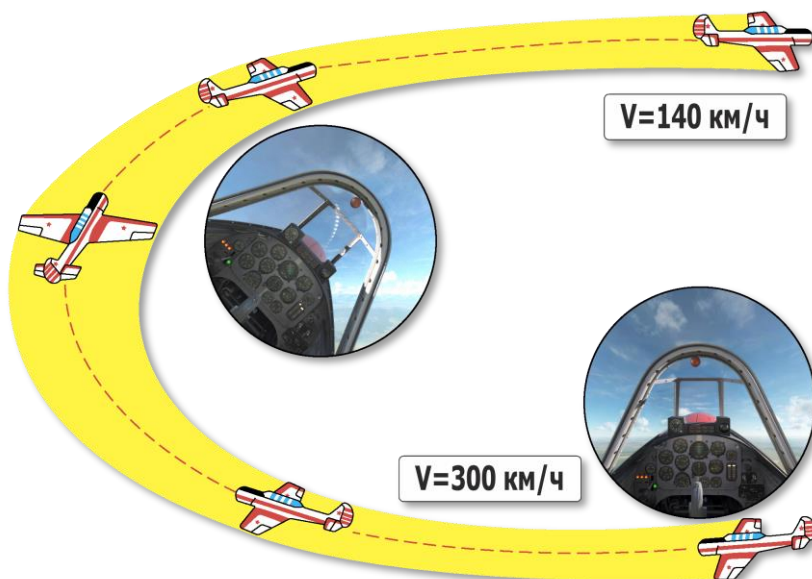

Figure 41. Hook turn.

Enter the maneuver like you would enter a steep turn, simultaneously lifting the aircraft nose relative to the horizon. I.e. as roll increases, the angle of climb should also increase. This means that once you turn 130 ° along the horizon, the aircraft should have a roll of 50 ° and a climb angle of 40 - 50 °. At 30 - 40 ° to the reference point, exit the maneuver as you would a steep turn: with energetic and coordinated inputs on the stick and pedals in the direction opposite of the turn. The engine RPM should remain at its maximum until the aircraft exits the roll. Afterwards, the nose should be lowered back to level flight.

Airspeed at the beginning of the exit should be at least 170 km/h, and no lower than 140 km/h at the end of the exit. After exiting the maneuver, smoothly push down on the stick and bring the aircraft

back into level flight, and only then reduce the engine RPM back to the predefined value. Altitude gain after this maneuver should be around 120 - 130 m.

Split S

Entering the split S maneuver is performed from level flight at an airspeed of 170 km/h, an RPM of 82%, and with full supercharging. Before starting the maneuver, again define a reference point for the exit and examine your surroundings. With smooth inputs on the control stick bring the plane to a pitch angle of 15 - 20 ° and maintain this angle by pitching down slightly. With smooth inputs on the control stick and minor inputs on the rudders in the desired direction, begin the split S maneuver. After the aircraft reaches a roll angle of 45°, push down on the stick slightly, taking care not to depart from the set reference point; if the aircraft is inverted, avoid lowering the nose. Once the aircraft reaches the inverted position, reset the rudder pedals to neutral and move the control stick in the direction opposite to the rotation, fixing the plane in the inverted position. Make sure that there is no roll and that the direction of flight remains fixed to the set landmark by cross referencing the nose and canopy position relative to the horizon.

When performing the split S, pay attention to the following:

- Coordination of the inputs on the stick and rudder pedals;
- Position of the windshield and nose relative to the horizon;
- Direction maintenance (towards the set reference point);
- Aircraft rotation speed.

After stopping the rotation of the aircraft, reduce supercharging by 2/3 of throttle lever's full range and, by gradually pulling up on the control stick, pull the aircraft into a dive. Exit from the dive should be performed at a speed of 200 - 210 km/h such that your return to horizontal flight should be at around 280 km/h.

During dive exit, pay attention to the following:

- Speed control;
- Intensiveness of the pitch-up input;
- Lack of roll;
- Exit direction.

Engine RPM increase determination must be performed after the aircraft has achieved a dive angle of 45 °.

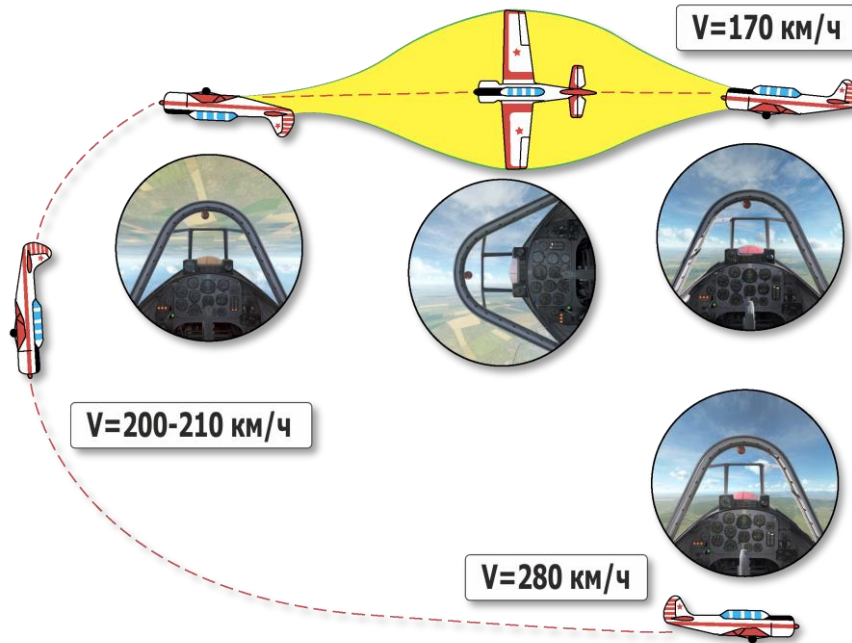

Figure 42. **Split S.**

Aileron Roll

Determine a reference point for entry and exit. Set an indicated airspeed of 230 km/h, 82% RPM and full supercharging.

Pull up and create an angle of climb of 15 - 20 °. Fix the aircraft in this position with a small pitch-down input and maneuver it in the direction of the aileron roll. As soon as the aircraft reaches a roll of 45 °, without slowing down the rotation, begin to pitch down slightly in order to prevent the aircraft nose position from going lower than the horizon (while in an inverted position.)

After the aircraft leaves the inverted position, it is necessary to keep the nose of the aircraft from dipping below the horizon by increasing yaw input in the direction of rotation. At 30 - 40 ° to level flight, pull up on the stick.

Pedal input should be minor during maneuver entry and slightly stronger on the second half of the roll. As the aircraft approaches level flight, yaw to exit in the opposite direction, and set yaw to neutral after the aircraft ceases rolling.

Pay attention to the following:

- uniform motion of the rudders and roll;
- direction of the roll relative to the reference point;
- moment of exiting the maneuver.

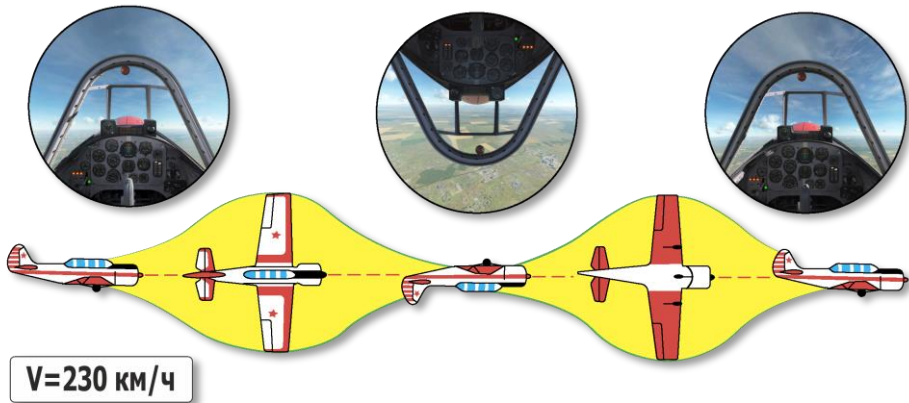

Figure 43. Aileron roll.

Vertical Loop (Nesterov's Loop)

Before executing the loop, set a reference point for exit. Indicated airspeed must be 300 km/h with an engine RPM of 82% and full supercharging. Gently pull the aircraft into a climb.

On entry, pay attention to the following:

- Angular velocity rate of increase (determined by G-load increase);
- Lack of roll and slip;
- Spatial awareness (pay special attention to the upper hemisphere).

Continue to pitch up and create a rotational speed such that at an angle of 40 - 50 ° the aircraft will have a G-load of 4 - 4.5G, and a speed of at least 140 km/h at the apex of the loop.

When performing the loop, pay attention to the following:

- Rotational speed (in terms of G-load $n_y > 3$);
- Forward speed (IAS);
- Lack of roll;
- Direction keeping.

Reassess the aircraft's position at the apex of the loop once the horizon comes back into view. Reduce supercharging if necessary and smoothly maneuver the aircraft into a dive.

When the aircraft's indicated airspeed reaches 200 km/h, pull back on the stick and return to horizontal flight in such a way that your airspeed at the end of the exit will be around 260 - 270 km/h.

On exiting the loop, pay attention to the following:

- Lack of roll and slip;
- G-load rate of increase;
- Direction keeping on exit (towards the set reference point);
- Airspeed;
- Transition moment at a dive angle of 50 - 40 °, during which the pilot must increase engine supercharging to the required values for the next maneuver.

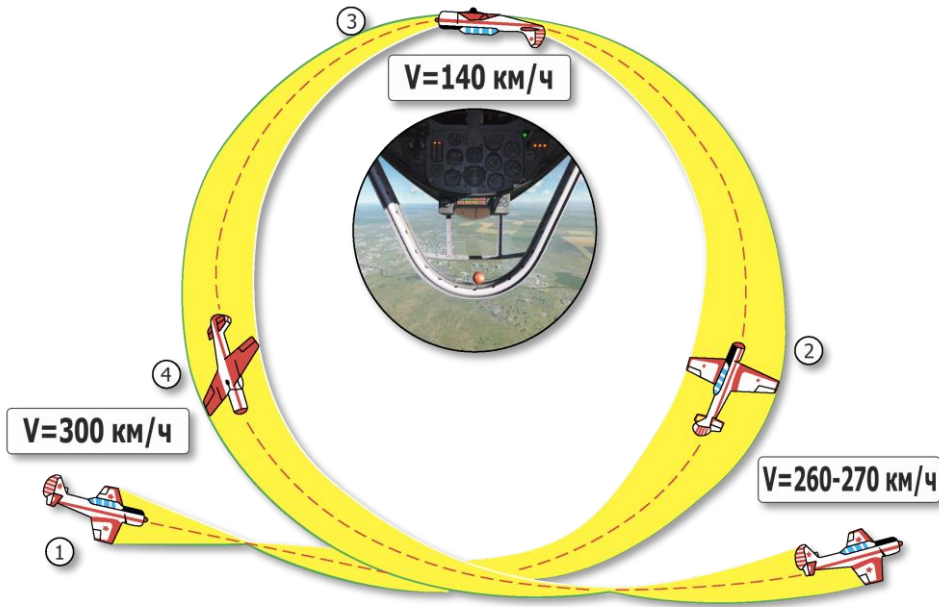

Figure 44. Vertical Loop.

Immelmann

Before executing the Immelmann, set a reference exit point. Indicated airspeed must be 320 km/h with an engine RPM of 82% and full supercharging.

The Immelmann turn is performed in the same way as the first half of vertical loop (Nesterov's loop, shown above), however, the pitch-up input should be somewhat more vigorous. When approaching the apex, when the aircraft will be in the inverted position with the upper edge of its canopy skirting the horizon, the pilot will have to maintain the aircraft in this position for a short while. Then, by deflecting the stick to the desired side, accompanied by minor deflections of the rudder pedal, the pilot

should begin the rotation of the aircraft. As soon as the aircraft enters level flight, neutralize the aircraft's rotation by deflecting the rudder to the side opposite of the direction of rotation, and then return them to the neutral position. The aircraft's speed before entering the Immelmann must be at least 150 km/h. If it is less than 140 km/h, the pilot must perform the second part of the Nesterov loop.

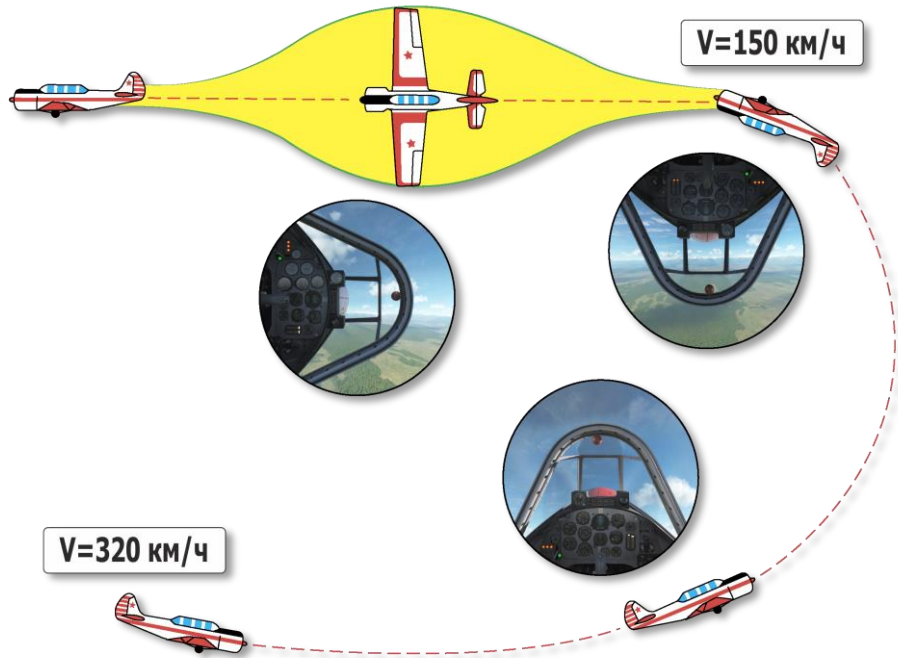

Figure 45. Immelmann turn.

Priorities when performing the Immelmann:

On entry:

- Airspeed and engine operational mode;
- Lack of roll;
- Creation of angular rotation (G-load indicator).

When performing the Immelmann:

- Starting point;
- Exit vector;
- Airspeed.

Spiral Descent

Set a reference point for entry and exit from the spiral. Set airspeed to 180 km/h.

Before entering the spiral, the pilot must first look around, paying special attention to the lower hemisphere.

Entry into the spiral must be performed with coordinated inputs on the control stick and rudder pedals. Maneuver the aircraft into the turn with a roll angle of $\gamma=30\dots45^\circ$.

On entry, pay attention to the following:

- simultaneous creation of roll and angular velocity;
- preservation of the glide angle;
- coordination of rudder action and airspeed constancy.

In the process of the maneuver, attention should be paid to:

- constancy of roll and angular velocity;
- the position of the visible parts of the canopy and nose relative to the horizon;
- coordination of rudder action and airspeed constancy (forward and vertical).

When performing a right-side spiral, the aircraft has a tendency to dip the nose and increase roll, while performing a left-side spiral sees a tendency of the aircraft to exceed the set angles as a result of the propeller action. These are easily compensated for by the corresponding inputs on the control stick.

Exiting the maneuver is done with smooth, coordinated movements on the control stick and rudder pedals. maneuver the aircraft from the turn into a dive, and from the dive back into level flight.

On exit, pay attention to the following:

- Simultaneous reduction of rotational speed and roll;
- Constancy of airspeed and coordinated rudder action.

Exiting the spiral

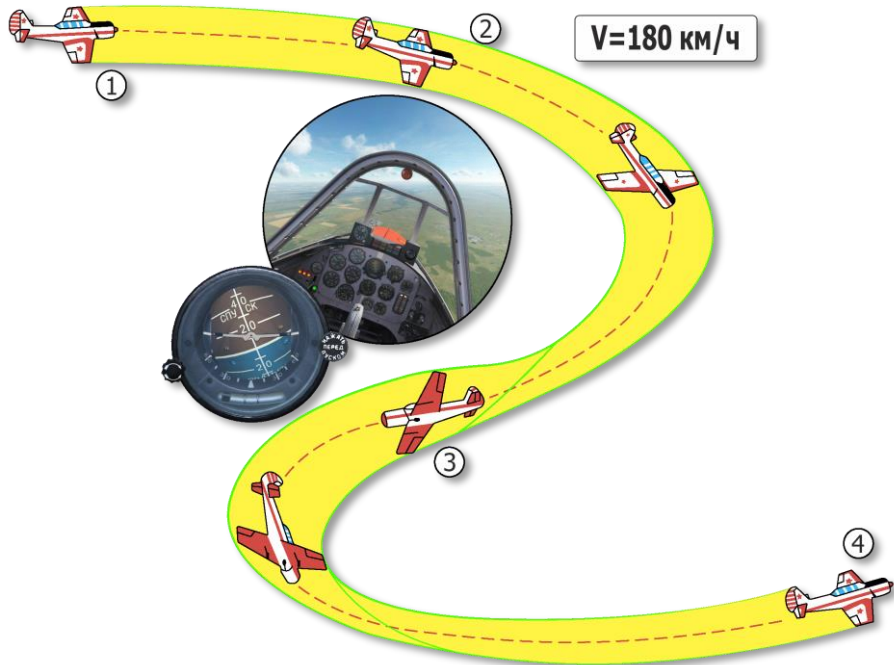

Figure 46. Spiral descent.

Gliding Descent

The gliding descent is carried out at an airspeed of 170 km/h. Again, before starting, set a reference point for the direction of your glide, then maneuver into a glide with an airspeed of 170 km/h and execute a turn at 10 - 15 ° in the direction opposite to your glide. Perform a roll of up to 30 ° in the direction of the glide, keeping the aircraft from turning by deflecting the rudder in the opposite direction. The direction of flight must be fixed on the pre-set landmark.

Exit from the glide must be performed by deflecting the control stick in the direction opposite to the roll, and, at the same rate the aircraft loses roll, bring the rudder pedals back to their neutral position.

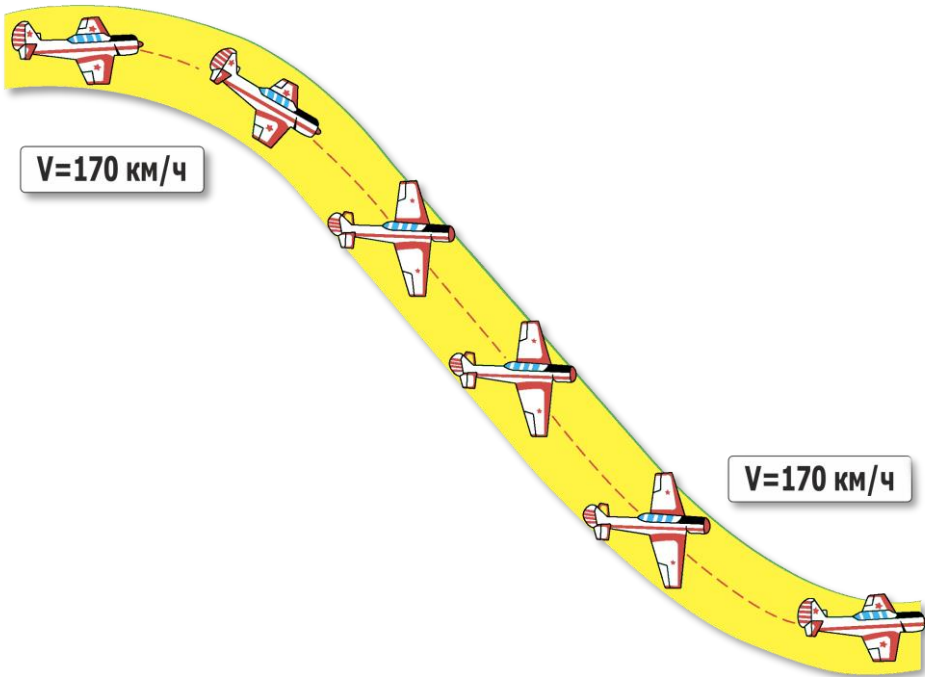

Figure 47. **Gliding descent.**

Climb

Climbing must be performed on the nominal engine operational mode at an airspeed of 170 km/h (150 km/h when flying with a ski undercarriage.) During the climb, monitor the aircraft instruments, which should show the following values:

- Cylinder head temperature: 140 - 190° C (maximum allowable temperature of 220° C);
- Oil temperature at engine inlet: 50 - 60° C;
- Engine oil pressure: 4 - 6 kg_F/cm².

If the temperature range of the engine exceeds the permissible limits during the climb, maneuver the aircraft back to horizontal flight and, with the butterfly valve and the shutters fully open, increase airspeed and reduce engine RPM.

If the measures taken do not lead to a drop in temperature, immediately abort the assignment, report the situation to flight control and, depending on the situation, land at an airfield.

Maximum rate of climb is attained by maintaining the following speeds:

- Ground level to 500 m – 170 km/h;
- 500 - 2000 m – 160 km/h;
- 2000 - 4000 m – 150 km/h.

Pilots flying the Yak-52 equipped with a ski undercarriage are advised to maintain an airspeed of 150 km/h during climb regardless of their current altitude.

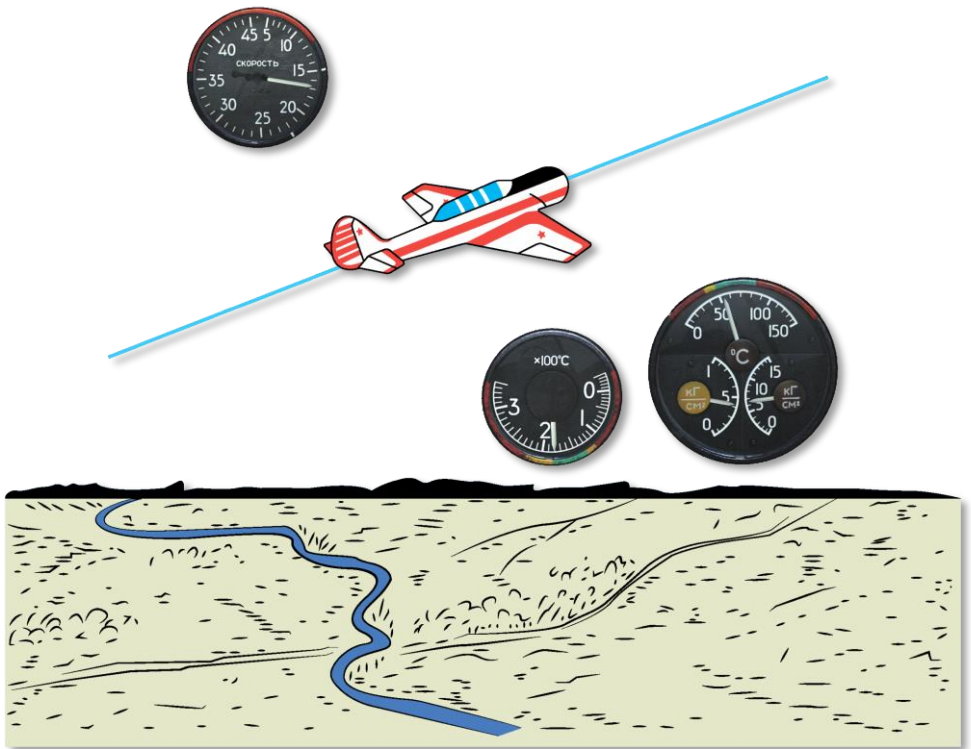

Figure 48. Climb.

Level Flight

Level flight may be performed from airspeeds of 130 km/h up to 300 km/h.

For prolonged flight in steady mode at low ambient temperatures, in order to avoid oil thickening in the rotor head cylinder, the pilot is recommended to transfer the propeller from fine pitch to coarse pitch and back, 2 to 3 times every 25 - 30 minutes of flight.

The pilot must also change engine RPM within the range of 67 - 55% and back to the default set values. A brief reduction in oil pressure, down to a minimum of 2 kgf/ cm² (and back to their original values after 8 - 11 seconds) is also allowed.

While in flight, periodically check the generator status as indicated by the "gen. failure" signal light on the indicator panel. Also check the voltage level.

No less than once per flight, and, for long flights, at least once per hour of flight: monitor the charging current of the onboard battery on the voltamperemeter. If the value of the charging current is equal to or greater than 30 A, immediately switch off the battery and do not turn it on until the end of the flight.

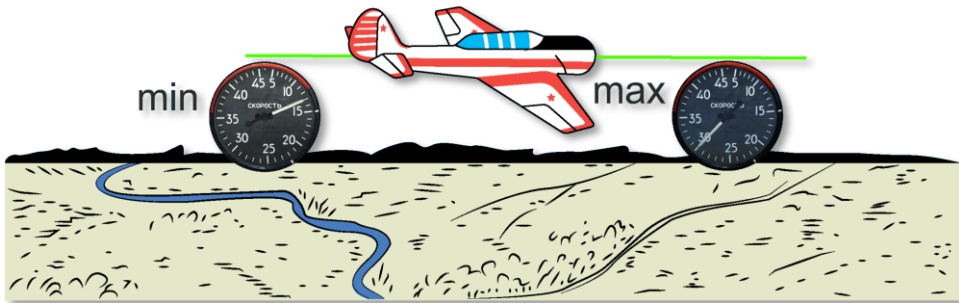

Figure 49. Level flight.

Descent

For prolonged descents with a fully lowered pitch on the propeller, closed butterfly valve nose blinds, the cylinder head temperature may drop below the minimum permissible value (140 °C). To prevent this, subsequent descents should be performed either at an increased engine operating mode or with periodic engine warm-up.

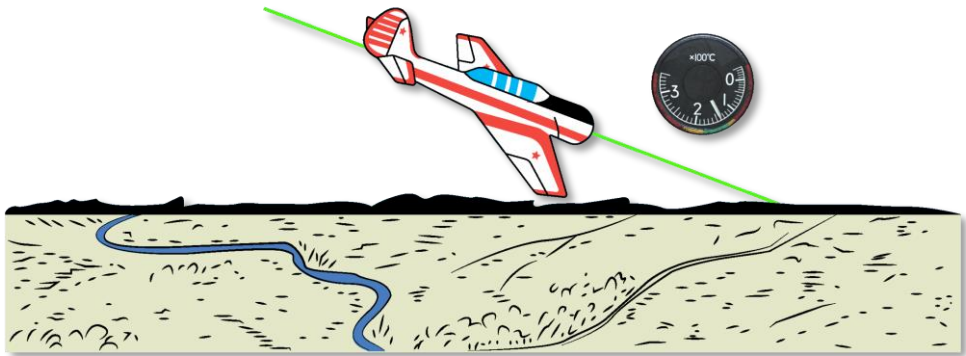

Figure 50. **Descent.**

Tailspin

The aircraft will break into an unintentional tailspin only if the pilot makes serious mistakes in their piloting, and the stall will begin without the telltale shaking of the aircraft.

For training purposes, tailspins are permitted only at altitudes of 1500 m or higher.

Before starting the maneuver, the pilot should look around and ensure that there are no other aircraft close by, taking special care to inspect the airspace under the aircraft. Set a landmark.

At a speed of 170 km/h and while in level flight, balance the aircraft with the elevator trimmers and check the readings of the instruments governing engine operation. Remove supercharging and, as the speed decreases, gently pull on the stick until you reach an airspeed of 110 km/h, all while keeping the aircraft from wing dropping.

When entering a tailspin, pay attention to the following:

- Position of the nose, which must be aligned with the horizon prior to the stall;
- Indicated airspeed;
- Vertical rate indicator reading;
- Direction to the chosen landmark.

As you reach an airspeed of 110 km/h, lower the aircraft cowl to the horizon line and deflect the rudder all the way in the direction of the spin. As soon as the aircraft begins to fall on its wing, drop the nose, pull the stick all the way back, keeping ailerons at neutral. Rudder movement during spin entry should be smooth. The procedure for entering right and left tailspins is the same.

During the tailspin, the rudders must be held in the same position as they were in during entry. The pattern of the tailspin will be uniform; the rotation will be vigorous, without jerking. The aircraft will rotate with a longitudinal axis bank angle towards the horizon of $50 - 70^\circ$. The right tailspin will see more vigorous rotation than the left one, due to the propeller action. The pilot's view during the tailspin should be in the direction of rotation at $25 - 30^\circ$ from the longitudinal axis of the aircraft and $30 - 40^\circ$ below the horizon line.

To exit the tailspin at 30° to the reference point, the pilot must first energetically push the rudder pedal all the way to the side opposite of the rotation, and then push down on the stick - keeping input strictly along the longitudinal axis of the aircraft. As soon as the rotation stops, immediately return the stick and pedals to the neutral position, attain an airspeed of $160 - 170$ km/h, then gradually pull back on the stick, taking the plane out of the dive. As the nose approaches the horizon, increase engine boost and bring the aircraft back into horizontal flight. Over the course of one spin turn (concluding in a return to level flight) the aircraft loses $250 - 300$ m; over two - 500 m.

The aircraft immediately leaves the tailspin at any sequence of step control input and even when the rudders are deflected to the neutral position.

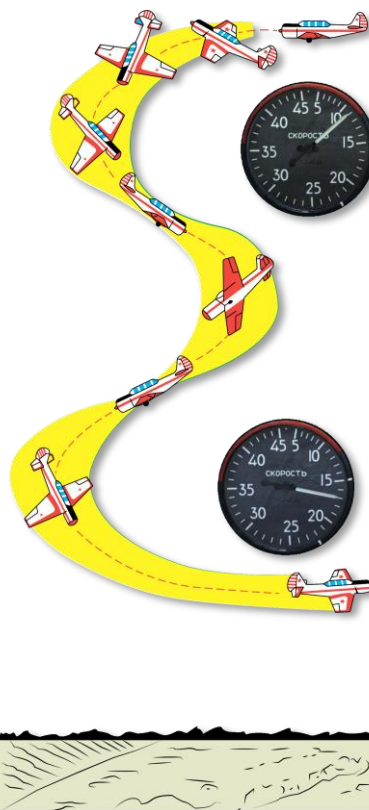

Figure 51. Tailspin.

Inverted Spin

The inverted tailspin is characterized by the following parameters:

- Rotational velocity (same as in the upright tailspin);
- the longitudinal axis slope to the horizon is close to the straight tailspin;

Compared to those experienced during an upright tailspin, the sensations experienced during an inverted tailspin are harsher on the pilot: the pilot is "pulled out" of their seat, the straps press on the shoulders, the feet "hang" on the straps of the pedals, the blood flows to the head, and temporary darkened vision is possible during exit from and entry into the spin.

Good seatbelt fitting is of great importance during exit from an inverted tailspin. Poor-fitting seatbelts will lead to the pilot hanging on the seatbelts; kept separate from the seat. Their legs may also become dislodged from the rudder pedals, making it almost impossible to control the aircraft.

To exit the inverted tailspin, the following measures must be taken:

- Reduce engine RPM;
- Set rudder pedals to neutral;
- Pull up on the stick to half of its full range from neutral.

This will result in the aircraft ceasing its rotation and immediately going into a dive. The pilot must then attain an airspeed of 180 - 200 km/h and return the aircraft to level flight. If the pilot intends to go from an inverted tailspin to an upright one, proceed in the usual manner.

Flat Spin

The process of transitioning from a spinning dive into a flat spin is characterized by the following:

- When executing a tail-spin, the control stick is deflected to the side opposite of the direction of rotation, and pulled towards the pilot;
- The aircraft smoothly raises its nose, accelerates the rotation, and reduces the loss of altitude over one turn;
- Rudder G-load increases significantly (forcing the stick towards the pilot);
- The pilot is forced towards the inner side of the cockpit;
- The aircraft rotates with a longitudinal axis slope towards the horizon of 20 - 30 °.

In the case of an involuntary flatspin, recovery is achieved by the following procedure:

- Fully push the rudder pedals to the side opposite of the aircraft's rotational direction. Afterwards push the stick down, towards the white line located on the dashboard.
- Return the pedals to neutral after the aircraft ceases to rotate. Attain a speed of 160 km/h and smoothly take the aircraft out of the dive. The rudder will be under a considerable G-load during flatspin recovery.
- When the aircraft's rollout from the flatspin takes more than two spin turns, it is necessary to make sure that the rudder pedals are deflected properly and to their full range. Afterwards, increase engine RPM to max in order to quickly take the aircraft out of the spin.

A more vigorous spin recovery is achieved by having the control stick deflected fully away from the pilot and in the direction of the spin. Likewise, having the stick pulled towards the pilot and away from the direction of the spin greatly slows down the aircraft's rollout.

Parachute Descent

During gliding at an airspeed of 170 km/h and with engine RPM set to minimum, reduce the speed to 110 km/h by smoothly pulling back on the stick. The aircraft will become unstable and begin to react

sluggishly to stick input. In order to maintain direction towards the chosen landmark, the pilot must deflect the rudder with greater intensity and range.

The aircraft's roll must be corrected not only with stick input but with energetic pedal movement as well.

To stop the aircraft's parachuting, smoothly push the stick back and gain a speed of at least 140 km/h. Parachuting may be performed only until an altitude of 1000 m.

Controlled Upward Spin

Performed at a speed of 280 km/h with an engine RPM of 82% and with full supercharging.

Before starting the maneuver, inspect the surrounding airspace, and select a reference point for entry and rollout. Make sure that the aircraft does not have any roll. Set the angle to 45 ° with a smooth yet energetic pull of the stick. Maintain and monitor this angle by cross-referencing the position of the semi-wings relative to the horizon, as well through the HSI. At a speed of 190 km/h, start the rotation by pushing the stick in the direction of rotation.

When the inverted position is reached, stop the rotation by pushing the stick in the opposite direction. Return the pedals to neutral. After rotation has stopped, the stick should also be returned to neutral. Maintain the angle. Afterwards, pull the stick smoothly but quickly in order to begin the transition back to level flight. Pay attention to the aircraft's G-load and do not allow the aircraft to stall. Reduce engine RPM after the vertical dive and depart from the wingover towards the chosen landmark. The rollout speed in level flight is determined by the required speed for the next maneuver, but should not be less than 280 km/h.

Horizontal Stall Turn

Performed at airspeeds of 170 to 190 km/h and an engine RPM of 82%.

Set an angle of climb of 15 - 20 ° with an energetic yet minor movement of the stick. Do not maintain this angle, instead vigorously and fully deflect the pedal in the rotational direction of the aileron roll. Cease all stick movement as soon as you begin deflecting the pedals. As soon as the aircraft turns, push the stick in the direction of the spin and push it forward slightly. During aircraft rotation, make no inputs on the rudder or engine RPM. At 20 - 30 ° before the completing the maneuver, energetically and simultaneously deflect the stick and pedals in the direction opposite of the rotational direction. The tempo and range of the rudder deflection depend on the rotational rate of the roll. As soon as the aircraft ceases to rotate, the rudder must be returned back to its neutral position.

FLYING SKILL ERRORS

Horizontal Maneuver Errors

When performing banks and spirals, the following deviations are possible:

- Entry into a deep spiral and stall into a rough pitch during banking;
- Increase in speed and loss of altitude during banking;
- Airspeed increase, loss of altitude, entry into a deep spiral when performing a spiral.

Potential causes:

- Pulling too hard during the banking turn or spiral causing excessive angles of attack;
- Dipping the aircraft during the process of the banking turn increasing roll beyond the specified amount and dipping the nose below the horizon;
- Dipping the aircraft during the process of the spiral increasing roll and angle of descent beyond the specified amount.

Corrective measures:

- When the aircraft begins to shake and lose airspeed during the turn or spiral (when the stick is pulled too far causing large angles of attack, position 1), reduce back pressure on the stick until the aircraft stops shaking (positions 2 and 3).
- When the aircraft attains forward and vertical speed and enters into a deep

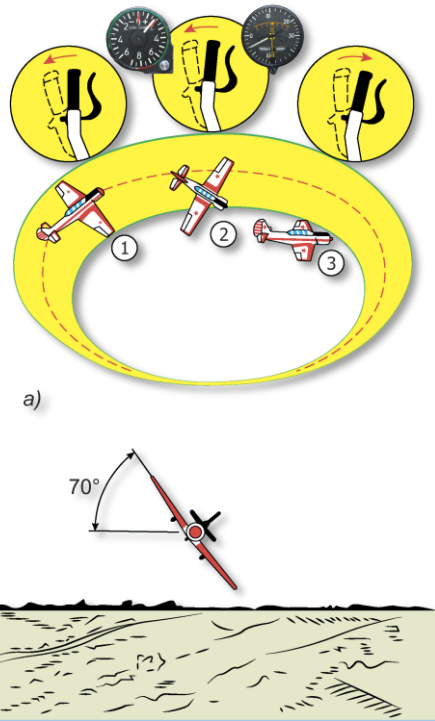

Figure 52. Typical errors when performing horizontal maneuvers.

spiral, the pilot must withdraw the aircraft from the roll, and then decrease the angle of descent. A slight deviation in the roll and pitch angles during the turn is eliminated by corresponding deflections of the stick and pedals.

- In the case of aircraft dipping with an increase in speed, it is first necessary to take the aircraft out of the bank, then, by pulling on the stick, bring it back to level flight.

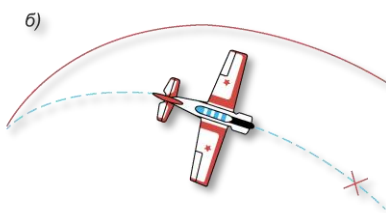

Figure 53. Taking the plane out of bank

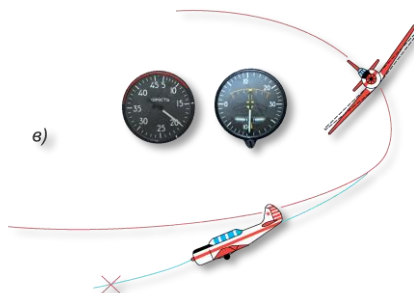

Figure 54. Pull the stick for level flight

Vertical Maneuver Errors

Error:

- Loss of speed and wing dropping when performing vertical maneuvers;

Potential causes:

- Sluggish or excessively vigorous manipulation of the stick while performing ascending aerobatics;

Corrective measures:

1a. If the back pressure on the stick is too weak or sluggish, increase the angular speed of rotation by means of more vigorous stick movement, taking care not to cause aircraft shaking;

2a. If the aircraft begins to shake due to excessive force on the stick, reduce the pullback speed until the shaking stops completely;

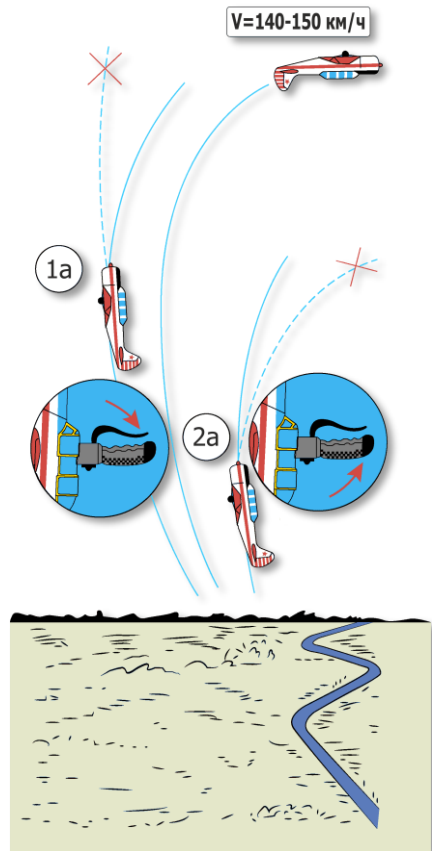

Figure 55. Typical errors when performing vertical maneuvers.

Error:

- Loss of speed and spin entry when reaching the apex of climbing maneuvers;

Potential causes:

- Excessive back pressure when in the higher parts of the ascending maneuvers;

Corrective measures:

1b. If dealing with a loss in airspeed when at the apex of the loop or Immelmann (airspeed less than 140 km/h): return the pedals to their neutral position and reduce the back pressure on the stick. Bring the aircraft into a dive;

2b. If dealing with a loss of speed (less than 150 km/h) in the second half of the hook turn, increase the roll and, with a coordinated movement of the pedal and the stick, bring the plane back to level flight, first aligning the nose of the aircraft with the horizon;

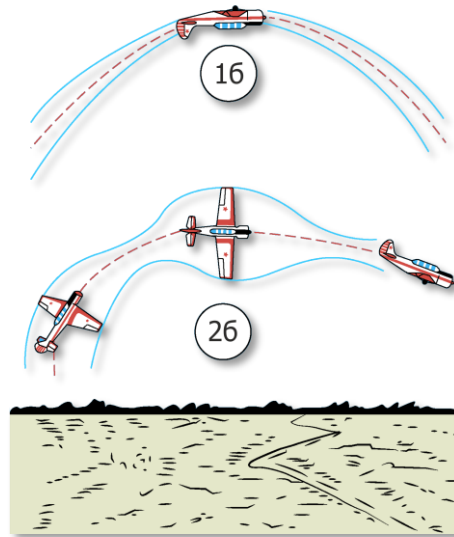

Figure 56. Typical errors in the execution of ascending figures.

Error:

- Wing dropping and stalling into a spinning rotation during the descending parts of the aerobatic maneuvers.

Potential causes:

- Sluggish or excessively vigorous pitching up when in the descending parts of the maneuvers.

Corrective measures:

1c - When back pressure on the stick is too weak (causing an increase in speed and loss of altitude), pull back on the stick to increase the angular velocity. During aircraft banking, first eliminate aircraft roll, then maneuver the aircraft from the dive;

2c. When back pressure is excessive, causing excessive G-loads, reduce back pressure on the stick until the aircraft stops shaking.

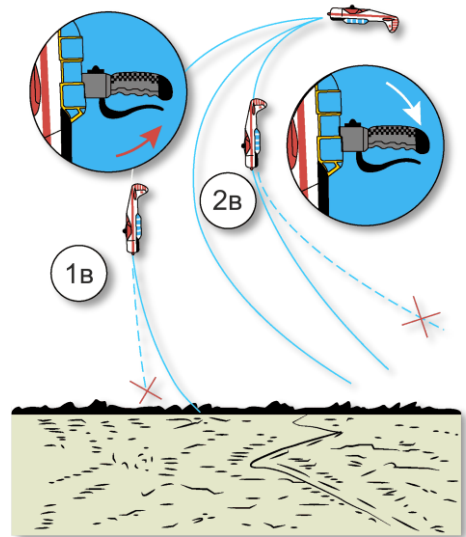

Figure 57. Typical errors in the execution of descending figures.

Characteristic Errors When Performing a Gliding Descent

- When entering the glide, the pedal prematurely deviates in the opposite direction - the aircraft turns to the side opposite to the glide direction;
- When the aircraft rolls at an angle greater than 30° - the aircraft turns in the direction of the glide;
- When the stick is pulled back excessively - the aircraft bleeds speed;
- When the stick is not kept pulled back - the aircraft increases speed;
- When the stick and pedals are inconsistently deflected on entry and rollout - the aircraft fails to maintain heading.

Characteristic Errors When Performing a Spin

When the entry into spin is performed during a climb, resulting in the stall beginning from the pitch-up angle at which the aircraft bleeds speed - spatial orientation is made extremely difficult, and the spin is performed from a variable angle of inclination of the longitudinal axis to the horizon.

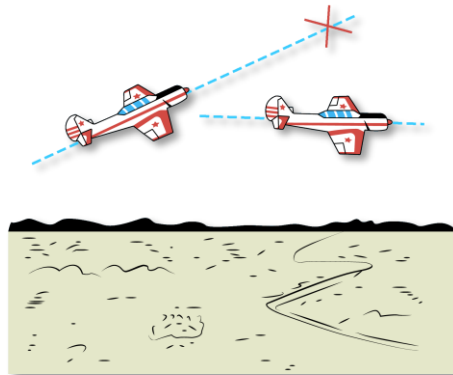

Figure 58. **Don't start a spin during climb!**

When yaw input is made too sharply - the aircraft will enter the spin very vigorously.

When entry into the spin is at a very high speed - the aircraft will perform a tuck-under break during gliding, then will go into a spin.

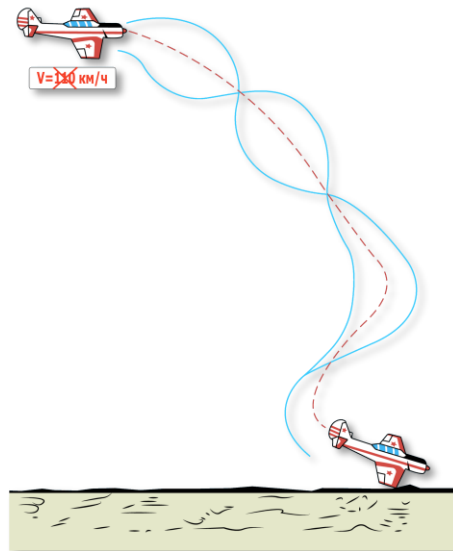

Figure 59. **Watch your speed before you start a spin!**

When the stick is pushed down during a spin - the aircraft, with roll and tail side-slip, will spontaneously exit from the spin.

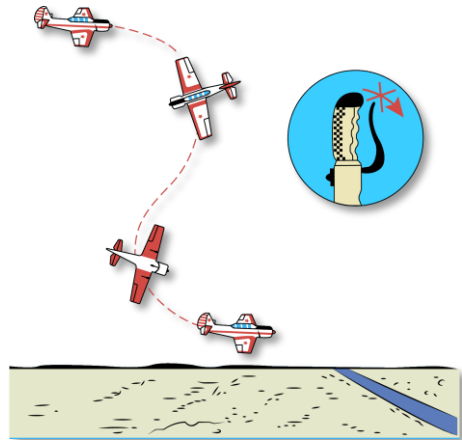

Figure 60. **Don't push the stick forward during the spin!**

When, during spin recovery, the pedal is deflected to the side opposite to the rotation of the aircraft, and the control stick is held pulled back - the aircraft will, after stopping its rotation, transition into a steep spiral in the direction of yaw, or into a spin in the opposite rotation.

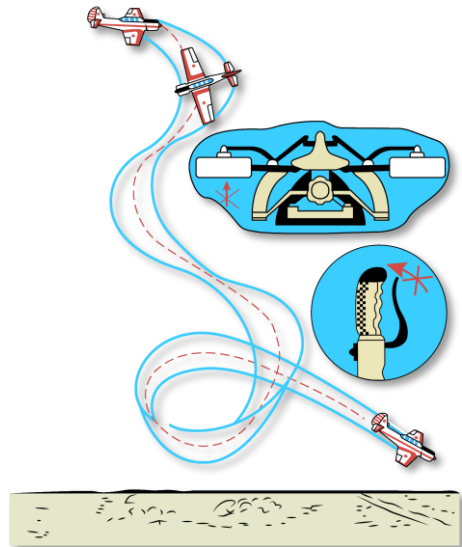

Figure 61. **Watch your inputs during the spin!**

Stalling from bank into spiral spin

When pulling too hard on the stick during a steep turn or a spiral, it is possible for the aircraft to stall into a right or left spin, depending on the direction of rudder deflection.

Stall from turn during climb

With an increase in the angle of climb or excessive deflection of the rudder, the aircraft "hangs" and falls into a spin in the direction of the rudder deflection.

Stall from turn during gliding

With a decrease in speed and excessive deflection of the rudder, the aircraft turns around and enters a spin in the direction of rudder deflection.

Warning. If the split-S, loops, or half-loops are incorrectly executed, a stall into inverted spin may occur; this happens when the aircraft bleeds too much speed while inverted, the stick is near the neutral position or is pushed forward, and the rudder pedal is deflected.

INSTRUMENT FLYING



INSTRUMENT FLYING

Illusory Sensations During Instrument Flight

During flight with zero visibility of terrain, the pilot may experience illusory senses of the aircraft's movement or attitude position. One of the major difficulties in instrument flying is the illusion of the aircraft's counter-rotation.

Level Flight Mode

Perform the following tasks for maintaining level flight:

- Set the airspeed to 180 km/h;
- Maintain zero values for pitch and roll on the AGI-1 horizontal situation indicator; the arrow on the vertical speed indicator must also be held at zero, while the DA-30 instrument's ball - held in the center;
- Systematically control the speed, altitude, heading, and engine speed, eliminating any deviations that may arise;
- Observe the readings on the instruments governing engine operation: the EMI-3m, TTsT-13k, and other control devices;
- Periodically cross-reference the readings on the DA-30 turn and slip indicator with the readings on the compass, the position of the aircraft silhouette, and the artificial horizon; make sure the artificial horizon is working properly (test by moving the control stick in different directions);
- If necessary, monitor the flight time using the onboard clock.

Deviations should be eliminated in the following manner:

- If the arrow of the turn and slip indicator points above the zero marker, then push down on the stick to pitch down. Conversely, if the arrow is pointing below the zero marker, pitch up. Ensure that the airspeed arrow is showing the given value;
- If the aircraft has roll, then move the stick to the side in order to reverse and eliminate the roll. Afterwards determine the magnitude of the aircraft's deviation from course using the compass, and return to course;
- If the aircraft's airspeed has changed, and the arrow of the turn and slip indicator sits at zero, check and change the engine RPM to return the airspeed to the mission set values.

To maintain level flight, check the instruments in the following order:

- artificial horizon - vertical speed indicator;
- artificial horizon - speed indicator;
- artificial horizon - gyromagnetic compass;
- artificial horizon - altimeter;
- artificial horizon - turn and slip indicator DA-30.
- Periodically turn your attention to the instruments governing engine operation



Figure 62. Instrument checking rotation for level flight.

Climbing

To maintain a climb, perform the following:

- Set the indicated airspeed to 170 km/h;
- Special attention is paid to keeping the silhouette on the artificial horizon at the zero divisions of the roll angle scale, and the turn-and-slip indicator ball at the center;
- Systematically monitor the speed on the US-450K airspeed indicator, monitor the cursor and changes in altitude. Periodically check the instruments that govern and monitor engine operation;
- The deviation in climb parameters is eliminated in the same way as in level flight.

To maintain a climb, check the instruments in the following order:

- artificial horizon - vertical speed indicator;
- artificial horizon - speed indicator;
- artificial horizon - vertical speed indicator, compass;
- artificial horizon - turn and slip indicator;
- artificial horizon - altimeter;
- artificial horizon - speed indicator, altimeter, compass, turn and slip indicator.
- Periodically switch attention to the engine monitoring devices.



Figure 63. Instrument checking rotation during climbing.

Gliding

Having set an airspeed of 170 km/h while in level flight, the pilot may transition the aircraft to a gliding descent.

To maintain a glide, perform the following:

- Monitor the artificial horizon and vertical speed indicator, ensuring that the arrow is kept at the marker corresponding to the required rate of descent, while the white line on the artificial horizon should be kept at the marker corresponding to the required angle of descent. The aircraft should have zero roll, while the ball of the turn-and-slip indicator should be kept centered;
- Systematically check the aircraft's airspeed (which should be 170 km/h), as well as its altitude and heading;
- During extended glides, periodically check the readings on the turn-and-slip indicator, and on the instruments governing engine operation;
- Deviations during descent are eliminated in the same way as in horizontal flight.

To maintain a glide, check the instruments in the following order:

- artificial horizon - vertical speed indicator;
- artificial horizon - speed indicator;
- artificial horizon - compass;

- artificial horizon - compass, vertical speed indicator;
- artificial horizon - turn and slip indicator;
- artificial horizon - speed indicator, altimeter;
- Periodically turn your attention to the engine status instruments.



Figure 64. Instrument checking rotation during gliding.

Turns on the Horizontal Plane With Rollout to Set Course

During all phases of the turn (entry, turn proper, rollout) - the pilot's attention should be directed towards the artificial horizon and the vertical speed indicator, plus the aircraft's compass during rollout (for determining the moment of rollout and the correctness of the aircraft's heading).

When deviations arise in the vertical speed indicator, the pilot must eliminate the deviation with stick input, then check the aircraft's speed and altitude.

If the arrow of the vertical speed indicator is sitting at zero and the aircraft's speed is greater than or less than 180 km/h, the pilot must check the engine RPM and set the required value.

1. Before entering the turn, set the speed to 180 km/h.
2. Check the compass.
3. Using the artificial horizon, maneuver the aircraft into a turn with a roll of 30 °.
4. Over the course of the turn, maintain the roll angle, keep the vertical speed indicator reading at zero, keep the turn-and-slip indicator ball in the center.
5. At 15 ... 20 ° to the exit vector, begin rollout from the turn.
6. After the rollout, make sure that the aircraft is flying in the correct heading. Once more check the altitude and airspeed of the aircraft.

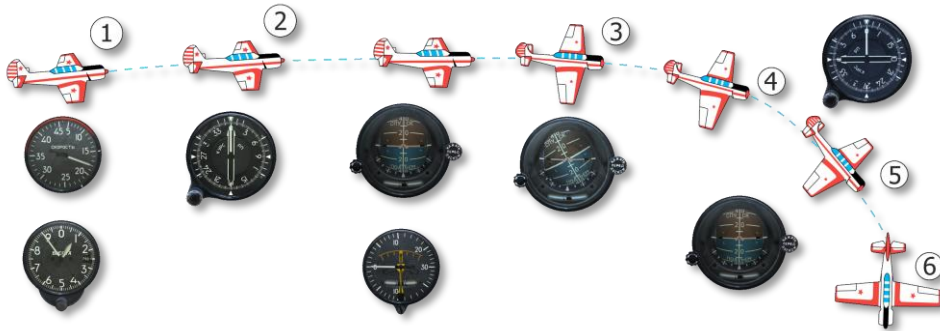

Figure 65. Turning during instrument flight.

Turning to Climb and Glide

Turning to climb

Procedure:

- Maneuver to a climb. Set an indicated airspeed of 170 km/h, holding the white line of the HSI at the zero division of the roll angle scale and simultaneously increasing the engine RPM to nominal.
- With an indicated airspeed of 170 km/h, maneuver the aircraft into a turn, setting a roll of 30 ° on the roll angle scale of the HSI.

Afterwards proceed as you would during a horizontal turn.

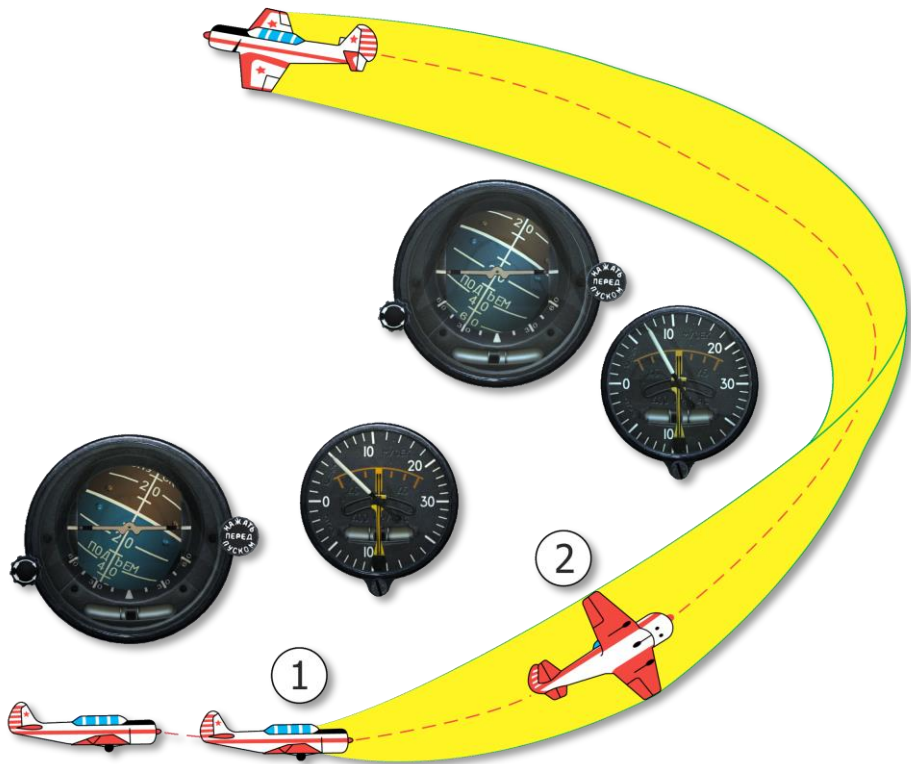

Figure 66. Turning to climb.

Turning to glide

Procedure:

- From horizontal flight with an indicated airspeed of 170 km / h and while keeping the HSI arrows at the zero divisions of the roll angle scale and monitoring the vertical speed indicator, smoothly maneuver the aircraft into a glide with the set vertical speed.
- While holding the arrow on the vertical speed indicator at the marker corresponding to the set/required vertical speed, maneuver the aircraft into the turn by rolling to 30 ° using the HSI roll angle scale.

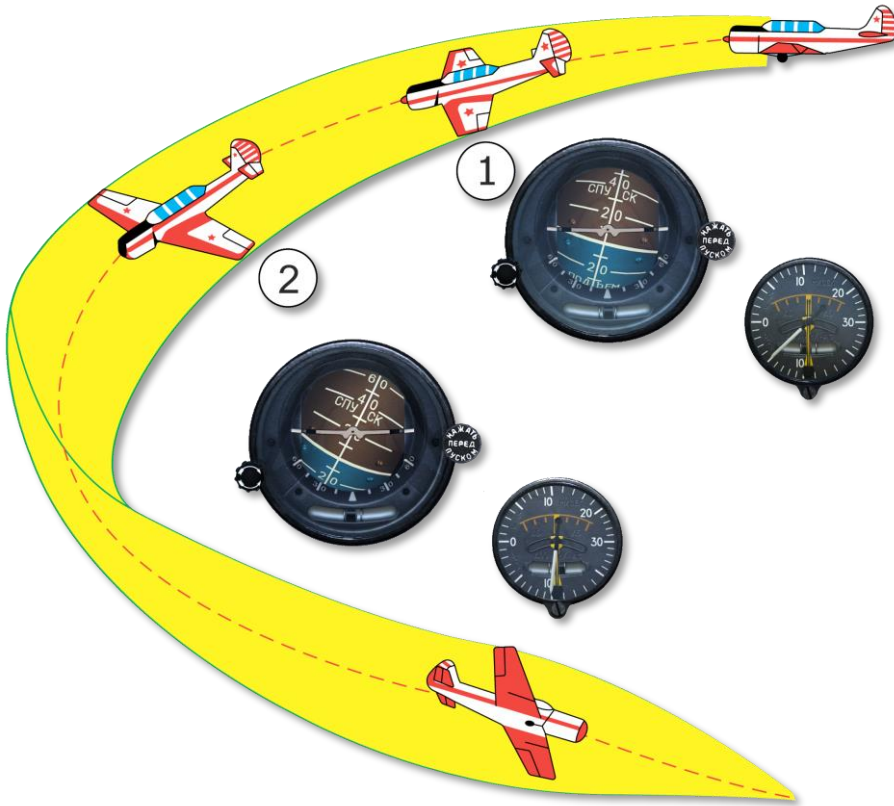

Figure 67. Turn to glide.

Guidelines for Instrument Flight with a Disabled Artificial Horizon

When the artificial horizon is disabled or inoperational, the pilot must use the turn-and-slip indicator and vertical altitude indicator on the DA-30 instrument, in conjunction with the airspeed indicator, the altimeter, and the compass. Because of the difficulty in determining the degree of roll using only the DA-30, piloting is made significantly more complex when operating without the artificial horizon. Stick inputs should be shorter and twofold, and if there are significant deviations from the set flight regime, recovery should be carried out over two or three stages.

Instrument flight using the DA-30:

- Closely monitor the readings on the DA-30 and constantly check for increases in aircraft roll.
- If the DA-30 arrow begins to deflect while in level flight, return the arrow to the center with stick input to the left or right, all while keeping the vertical speed indicator needle at zero and the pedals at neutral.
- Remember that, when the pedal is deflected the arrow on the instrument will move to the side of the aircraft's turn, i.e. following the pedal, while the ball, on the contrary, will move to the side opposite of the direction of pedal deflection.
- When the ball is tilted to the right or left during level flight (with the DA-30 arrow in the center), deflect the pedal in the direction of the ball in order to return the ball to the center, while holding the DA-30 arrow in the center with stick inputs.
- Perform turns with 15 - 20 ° of roll by deflecting the arrow on the DA-30 for one increment at an indicated airspeed of 200 km/h.
- If there are significant deviations in the vertical speed indicator arrow, return it to the zero position by twofold movements on the control stick, over two or three phases.

Instrument checking rotation during flight with a disabled artificial horizon

Monitor your instruments in the following order:

- Turn and slip indicator - vertical speed indicator;
- Turn and slip indicator - speed indicator;
- Turn and slip indicator - vertical speed indicator;
- Turn and slip indicator - altimeter;
- Turn and slip indicator - vertical speed indicator;
- Turn and slip indicator - compass.

Periodically turn your attention to the engine monitoring devices. When flying with malfunctioning (or disabled) barometric instruments, the flight modes must be maintained with the help of the artificial horizon and by engine RPM. Altitude control during climb or descent is done by reading the artificial horizon showing the aircraft's vertical speed and by monitoring the elapsed flight time by the hour.



Figure 68. Instrument checking rotation during flight using the DA-30.

EMERGENCY PROCEDURES



EMERGENCY PROCEDURES

Engine Trouble

Engine failure in flight

If the engine fails during takeoff, perform the following during the climb to the first turn::

- Maneuver the aircraft into a glide
- Retract the undercarriage.
- Shut off the fuel emergency shutoff cock.
- Switch off the magnetos, the aircraft battery, and ignition.
- Open the canopy.

Continue moving directly ahead and land without changing course. If such a course of action threatens the life of the pilot (i.e. due to obstacles preventing a safe landing), the pilot must then change their landing direction.

If the engine fails during inverted flight:

- Execute a 180-degree roll and maneuver the aircraft back into level flight.
- Set a glide speed of 170-180 km/h.
- Set the engine control lever to approximately one-third of its full range.
- Turn the handle of the priming pump to the "pipeline fill" position and pump up the fuel up to a pressure of 0.1-0.2 kg_F / cm².

Note. To facilitate engine startup, it is recommended to inject fuel into the engine cylinders.

Once the engine is again operational, first put the engine control lever into the takeoff position for 1-2 seconds, and then set the mode required for flight continuation.

Warning! A loss in altitude of 300 - 350 m will occur during the above procedure (from engine failure up until engine restart.)

Fuel pressure drop

The following may be signs of a drop in the aircraft's fuel pressure.

- Disruptions in the engine operation, accompanied by a drop in the engine's crankshaft speed, a drop in boost, and engine shaking;
- The fuel pressure shown on the instruments drops below the permissible value.

If a drop in the aircraft's fuel pressure occurs, the pilot must perform the following:

- Turn the handle of the priming pump to the "pipeline fill" position and pump the fuel into the fuel system while monitoring the pressure on the pressure gauge.
- Abort the flight and immediately land on the aircraft's home or secondary airfield.

Engine shaking

If engine shaking occurs, the pilot must perform the following:

- In all cases (with the exception of a drop in fuel pressure), pull the engine control lever all the way back, then pull back on the stick to maneuver the aircraft into a glide, setting the required flight speed.
- If the above procedure eliminates the shaking, smoothly move the engine control lever forward and set the engine operating mode required for level flight.
- If the shaking does not stop after changing the engine operating mode, the pilot must then increase the engine speed to 70% and activate the spark plugs.
- If the shaking does not stop after this, use the engine control lever and the propeller pitch control lever to minimize the intensity of the engine shaking, then, using these settings, land back at the airfield.

Propeller overspeeding

Signs of propeller overspeeding:

- Mild engine shaking.
- Increase in engine crankshaft speed.
- A sharp change in the sound of the operational engine.

If propeller overspeeding occurs during takeoff, perform the following:

- During the takeoff roll - abort the takeoff, and taxi back to the aircraft parking lot for troubleshooting, but only if the aircraft is able to safely taxi back to its parking space.
- After liftoff - increase propeller pitch by small movements on the propeller pitch controller and continue the takeoff. Retract the undercarriage at an altitude of 15 - 20 m, proceed to perform a normal circular flight, then land at the airfield.

If propeller overspeeding occurs during a glide:

- Completely remove the engine boost and increase propeller pitch.

In-Flight Fire

If a fire breaks out onboard the aircraft while the aircraft is in flight, the pilot must perform the following:

- Shut the fire cock; turn off the magneto, ignition, and generator.

- Maneuver the aircraft to a glide and if necessary apply slip to break up the flames.
- If an airfield landing is impossible, choose a site outside of the airfield and perform an emergency landing.

Off-field landings must be performed only with a retracted undercarriage.

If attempts to extinguish the fire fail, and there are no viable sites for an off-field landing, the pilots must abandon the aircraft by a parachute landing.

Emergency Landing with a Dead Engine

In case of engine failure, the pilot must immediately perform an emergency landing at the airfield or at an off-field site.

The available gliding range in case of engine failure is determined by the aerodynamic efficiency of the aircraft and its altitude reserve. It is recommended to perform the gliding approach with retracted undercarriage and landing flaps at a speed of 160 km/h. The aerodynamic efficiency and the estimated gliding range respectively are:

$$K = 7; L = K \cdot H$$

Where H – altitude, in m;

K – aerodynamic efficiency.

When calculating the available gliding range and assessing the feasibility of landing at the airfield, consideration should be given to the reductions in range caused by the execution of turns and maneuvers that are necessary prior to landing. When performing a 180 ° turn with a roll of 45 °, the range is reduced by about 1 km.

To ensure access to the aerodrome at an altitude of 400 m, which, in turn, ensures the safe execution of the pre-landing maneuvers, it is necessary to reduce the estimated gliding distance by 3 km. Thus, the available gliding range, having taken into account the turns to the airfield and providing the necessary margin of altitude above the airfield, is:

- If $H=2000$ m – 10 km.
- If $H=3000$ m – 17 km.
- If $H=4000$ m – 24 km.

Perform the turns with a roll of 45 ° in order to minimize the loss of altitude. In this case, the radius of the turn will be 200 m, while the rate of descent will be 8 m/s and the loss of altitude will be 220 m when performing a 360 ° turn.

When deploying the undercarriage, the aerodynamic efficiency and the rate of descent will change slightly.

With the undercarriage and landing flaps deployed, the aerodynamic efficiency of the aircraft will be 5.5.

When approaching with a headwind, the available gliding range is reduced, with 5 m/s of wind speed corresponding to a 10% reduction in range.

When entering the airfield with a runway heading, the pilot is advised to perform a pre-landing maneuver of two 180 ° turns, beginning the first turn just above the center of the runway (airfield), and beginning the second turn at the reference altitude:

$$H_k = \frac{H_{\text{HCK}}}{2}$$

Where H_{HCK} – aircraft recovery altitude to the center of the runway, in m.

If there is any wind present, the starting point of the pre-landing maneuver should be shifted away from the center of the runway and toward the wind, independent of the aircraft's exit heading to the center of the runway, by a distance of:

$$\Delta L = 50 \cdot W$$

Where W – wind speed, m/s.

When entering the runway with a landing course and a headwind, the beginning of the first turn must be made, after passing the center of the runway, after a duration of time (in seconds) numerically equal to the wind speed in m/s.

In case of side wind, the lateral displacement of the aircraft on the center of the runway should be:

$$\Delta L \approx 20 \cdot W_{\text{бок}}$$

Where $W_{\text{бок}}$ is wind speed in m/s.

When approaching the runway at an altitude of 400-600 m, a headwind of 5 m/s will shift the starting point of the pre-landing maneuver by a distance of 250 m, which corresponds to the time elapsed from the moment of passing the center of the runway to the beginning of the maneuver - 5 s.

With a side wind of 5 m/s, the aircraft should be maneuvered to the center of the runway with a lateral displacement of 100 m.

When performing an emergency landing with a failed engine, the pilot must perform the following:

- With a roll of 45°, turn towards the airfield.
- Set an indicated airspeed of 160 km/h.
- Request permission for landing from the airfield ATC. Also request for weather data (atmospheric pressure, wind speed and heading.)
- Shut off the fire cock, switch off the magnetos, the aircraft battery, and ignition.
- Identify the aircraft's flight altitude. (The altimeter should be set to the airfield's atmospheric pressure.) Having calculated the available gliding distance, assess the viability of an emergency landing on the airfield.

Note: If the altitude reserve is insufficient for a landing at the airfield, the emergency landing should be performed at a selected site outside of the airfield, either with pre-landing maneuvers or while flying in a straight line.

With the expected exit to the center of the runway is at an altitude of less than 400 m, landing is possible only from straight flight. In this case, the pilot must perform a "snake" maneuver and slip in such a way as to ensure that the direction of the glide path ends at the center of the runway.

When entering the runway center at an altitude of 400-600 m, perform a pre-landing maneuver depending on the course of the runway exit. When entering the runway at an altitude of more than 600 m, perform a spiral in the center of the runway with a landing course.

After entering the landing line (when landing from a straight line at a distance of 1 km from the center of the runway), deploy the undercarriage and make sure that the aircraft's descent will end at the start point for the flare-out, located at the beginning of the runway (or off-field landing site).

If the descent path leads beyond the start-point of the flare-out, then apply slip such that the plane will exit the descent at the start-point.

At a height of at least 50 m, switch off the battery, and open the cockpit canopy.

At an altitude of 10-15 m, with smooth movements on the control stick, begin aligning yourself so as to finish the flare at an altitude of 0.5 - 1 m. The landing speed will then be 125-130 km/h.

When performing an emergency landing with a failed engine at an airfield equipped with a Short-Range NDB/inner marker (given the standard distance of the inner marker of 1000 m from the end of the runway), it is recommended to use the automatic radiocompass readings for entering the airfield and for planning your pre-landing maneuvers.

The pre-landing maneuvers in this case are carried out with respect to the inner marker.

The minimum exit altitude to the inner marker should be no less than 550 m and the reference altitude.

$$H_k = \frac{H_{\text{нсх}}}{2} + 20$$

When exiting to the inner marker at an altitude of 800 m, perform a spiral in such a way that you will exit the maneuver above the short-range NDB with the landing course and at an altitude of 500 - 700 m.

The minimum altitude for passing by the inner marker during windless conditions is 200 m. This allows the pilot to land the aircraft on the runway at a distance of 100-200 m from the end.

In a headwind, the minimum altitude for passing by the inner marker and onto the runway is increased by 5 m for every 1 m/s of wind speed.

The maximum excess altitude while above the runway, which is bled off by sliding with a roll of 5 ° with an available maneuvering distance of 1000 m, is 50 m.

In the case of an overshoot of the calculated point of landing, release the landing flaps to remove the excess altitude.

Parachute Jump

In all situations where an immediate risk of loss of life presents itself, the pilot must abandon the aircraft by a parachute jump.

This decision must be made by the commander of the flight crew.

Before attempting a parachute jump, the pilot must perform the following:

- Transfer the aircraft to a straight-line horizontal flight with an airspeed of $V = 190$ km/h.
- Close the fire cock, turn off the magneto, ignition, battery, and generator.
- Disconnect the headset connector.
- Open the canopy.
- Unfasten the seat belts.
- Remove legs from the pedals and pull them over to the cup of the pilot's seat.

Abandoning a burning aircraft at an altitude higher than the altitude set on the parachute device is performed with a delay in opening the parachute of at least 3-5 seconds.

The minimum safe altitude of an emergency parachute jump from an aircraft in horizontal flight is 120 m when the S-4U parachute is automatically activated.

ARK-15M Radiocompass Failure

In-flight failure of the radiocompass can be determined by one of the following signs:

- The arrow of the radio compass indicator remains stationary even when there is a change in flight heading.
- No responses from the radio callsigns to which the radio compass is tuned.
- Large swings or continuous rotation of the pointer of the radio compass.

In case of radiocompass failure:

- Ensure that the radiocompass, aircraft intercom, and PT-200 circuit breakers are switched on at the left horizontal panel.
- The switch on the control panel of the radiocompass is set to the "Комп" position.
- Check the radio compass setting.
- Check the position of the NDB switch.
- Request a course to your airfield and periodically monitor the correctness of your current course by using the gyromagnetic compass and the bearing information received from the ATC.

Generator Failure

Failure of the generator in flight is signalled by the illumination of the "Generator failure" signal light and the deviation of the voltamperemeter arrow to the right from zero.

In case of generator failure:

- Switch off the generator.
- Switch on the radio station transmitter only in short bursts and only when needed.
- Abort the mission and land at the home airfield.

Note.

1. If the battery switches off as a result of exceeding the charge current by more than 30 A, after the "Generator Failure" indicator light switches on, it is necessary to turn on the battery, and proceed as described above.
2. The rechargeable battery can provide power to all onboard consumers for a period of no longer than 30 minutes.

Switching off unnecessary consumers will lead to an increase in the remaining battery time for the rest of the active consumers.

Airspeed Indicator Failure

Airspeed indicator failures may happen over time (and not instantly.) Thus, before taking any measures, the pilot needs to make sure whether a failure has indeed occurred. For this, without changing the engine's mode of operation, smoothly transfer the aircraft to a dive or climb using the artificial horizon and altimeter.

If the speed readings do not correspond to the current mode of flight, while the remaining devices operate normally, the pilot can be sure that an airspeed indicator failure has occurred.

In this case, perform the following:

- Abort the mission and prepare to land at the airfield.
- Control over the flight mode must be maintained using the artificial horizon, altimeter, engine crankshaft speed and boost monitors, as well as by using the position of the aircraft cowl relative to the horizon.

The recommended values for the engine crankshaft speed and engine boost during different modes of flight are shown below in Table 5.

Table 5.

Flight Mode	Indicated Air-speed, km/h	Vertical Speed, km/h	Engine Crankshaft Speed, %	Engine Boost, mmHg
Climb	160	5	70	700
Level flight	170	0	64	500
Turns in level flight	170	0	64	600
Gliding	160	3	41	300

Altimeter Failure

In case of altimeter failure:

- Abort the mission and prepare to land at the airfield.
- Control over the flight mode must be maintained using the airspeed indicator, the artificial horizon, vertical rate indicator, and engine crankshaft speed indicator.

Vertical Rate Indicator Failure

In case of vertical rate indicator failure:

- Abort the mission and prepare to land at the airfield.
- Control over the flight mode must be maintained using the airspeed indicator, artificial horizon, altimeter, engine crankshaft speed and boost monitors, as well as by using the position of the aircraft cowl relative to the horizon.

DS-1 Failure Sensor Heating Failure

If the signal light for "failure detector heating" goes out on the aircraft indicator panel, this can mean that the heating system has failed.

Once the pilot notices that the light has gone out, they must first double check the status of the failure detector heater circuit breaker (if it is switched on) and the correct operation of the signal light by pressing on the signal light test button. If the circuit breaker is switched on and the lights are operational, then the failure sensor heating has failed. If this happens, the pilot must take extra caution in maintaining control over the aircraft's flight speed, especially when on approach for landing.

Emergency Undercarriage Deployment

- If the undercarriage becomes impossible to deploy normally, the pilot must perform an emergency undercarriage deployment. To do this:
- Check the air pressure of the emergency cylinder (normal air pressure would be 40-50 kg_F / cm²).
- Close the main valve to prevent air bleeding in the event of the non-return valve's failure.
- Set the undercarriage valve levers in both cabins to the "neutral" position.
- Open the emergency exit valve on the right side of the cockpit.
- Check the undercarriage status. A deployed undercarriage should cause the signal lights to flash green.
- Set the valve handles in both cabins to the "released" position.
- After the flight is over and the engine is switched off, close the valve of the emergency system.

Warning! Retracting the undercarriage after a successful emergency deployment is strictly prohibited.

The aircraft's glide speed after the fourth turn up until the flare-out altitude should be 160 - 170 km/h. Performing a landing with retracted landing flaps is no different from landings with the flaps deployed. In this case, the pilot must keep in mind that the gliding range, flare-out time and landing speed will be somewhat greater than when landing with the flaps released.

FORMATION FLYING



FORMATION FLYING DRILLS

Single-File Takeoff

Procedure:

- Before taking off, the lead aircraft must ensure that there are no other aircraft currently on or about to roll on to the runway. They must also ensure that there are no aircraft currently in the process of waving off.
- The lead aircraft begins taxiing onto the runway along with the trailing aircraft.
- After taxiing procedures, the trailing craft reports to the lead craft that they are ready for takeoff.
- The lead craft takes off.
- After the lead craft achieves lift-off, the trailing craft throttles up and takes off.
- At an altitude of 20 - 25 m the undercarriage is retracted, engine RPM is set to 83% with full supercharging and, while maintaining visual on the lead craft, the trailing craft will begin their approach in order to hold formation.

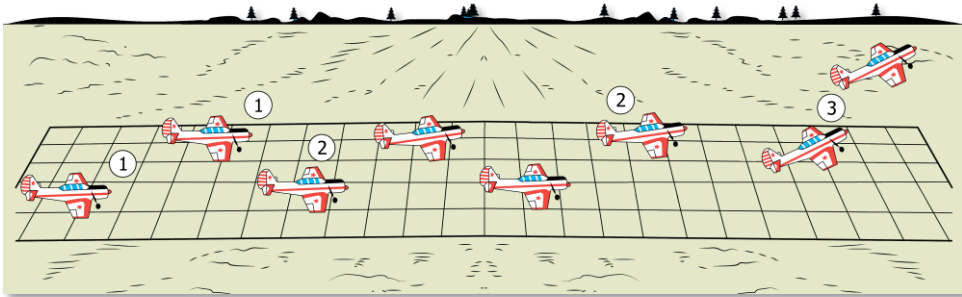

Figure 69. **Single-File Takeoff.**

Pair Takeoff

Procedure:

1. The trailing aircraft should: keep a distance of 30x30 m when taking off from a concrete runway and 50x50 m when taking off a rough airstrip, inform the lead aircraft when they are ready to take off, and, while keeping the aircraft on the brakes, set engine RPM to maximum. Begin the takeoff run upon receiving the order from the lead aircraft.
2. The nose-up moment is determined by the lead aircraft. Pay attention to the following:
 - How high the front wheel is held. Maintain this position until the end of the takeoff run;

- Engine operation;
 - Preservation of the takeoff heading, distance and interval. Use the lead aircraft as reference.
3. Synchronization of liftoff between the lead and trailing craft. During flare-up, ensure that:
 - The correct interval and distance are preserved;
 - The trailing aircraft retracts its undercarriage in sync with the lead aircraft.
 4. Retract the undercarriage together with the lead aircraft. Keep trailing the lead aircraft such that both aircraft are on the same plane. Monitor the temperature of the engine.

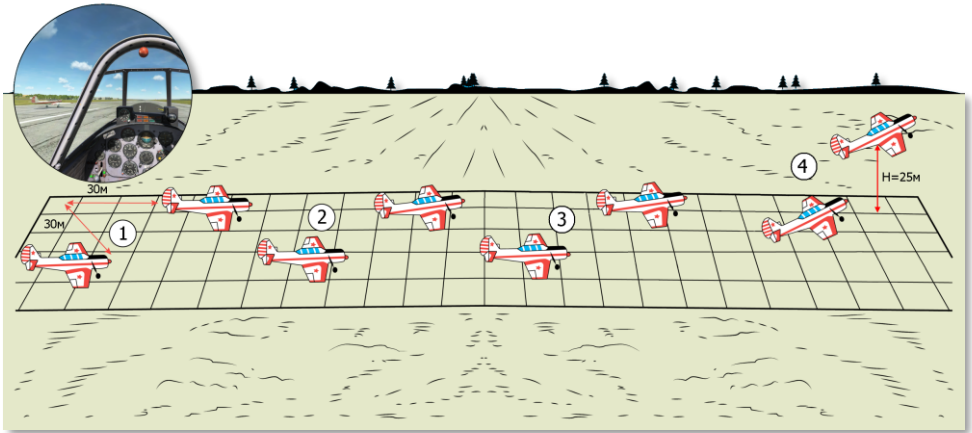

Figure 70. **Pair Takeoff.**

Joining Formation

When the interval approaches the double interval (50 - 60 m), deflect the rudder to stop its reduction. Then, by increasing engine speed reduce the distance at the double interval to 60 - 70 m with a separation of 3 - 5 m.

When approaching the set distance, reduce the engine RPM and, with smooth, fine inputs on the pedals, and without creating a lot of inertia for your aircraft, shorten interval back to the needed values.

When on approach, avoid creating roll in the direction of the lead craft; closely monitor the shortening of the interval and avoid sudden movements of the aircraft by using the supercharging and pitch levers.

During single-file takeoff, joining formation is done in the same order at an altitude not lower than 150 m.

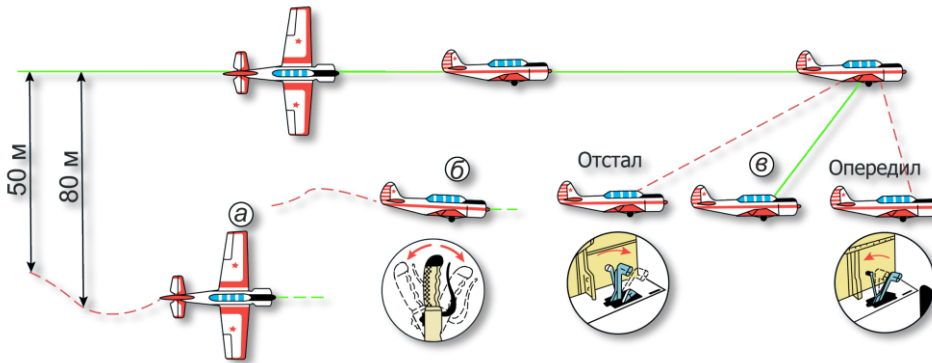

Figure 71. **Joining Formation.**

Straight-line Formation Flight and Climb

Procedure:

- When flying in a straight line, keep the aircraft in line with the lead craft, which should be visible at all times.
- The distance and interval will be at 60 - 70 x 25 - 30 m; line of sight to the lead craft should be from the pilot's eye through the middle of the side window of the windshield, through the tip of the horizontal tail of the lead aircraft and the pilot in the front cabin.
- As distance increases, increase the engine speed smoothly and, as you approach the set speed, reduce engine speed. If the distance decreases, gradually reduce the speed, fall behind and restore the required distance.

Maintain the proper interval during straight line flight by small, smooth inputs on the rudder, without any roll.

Climbing while in formation

When climbing, the lead craft must ensure that the trailing craft does not lag behind on takeoff and formation joining. Otherwise, reduce engine RPM and climb angle. Reduce airspeed up to 160 km/h minimum, until the trailing craft achieves the necessary interval and distance. Afterwards set the climb speed to 170 km/h. The lead craft should perform the climb at an RPM that allows the trailing craft to maneuver with its own RPM.

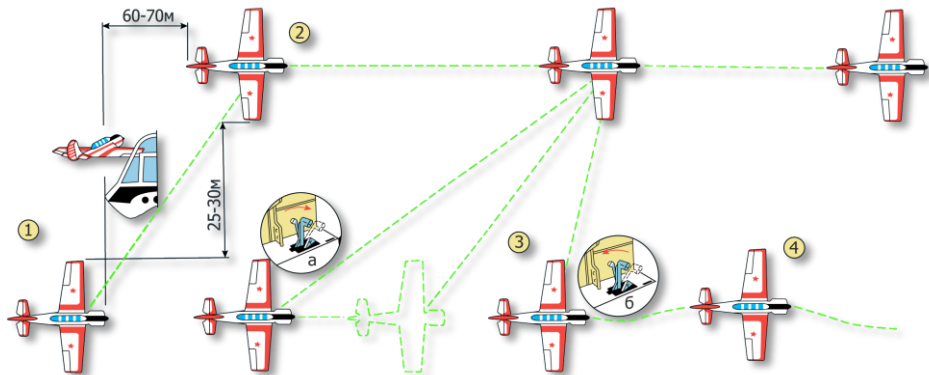

Figure 72. **Straight-line Formation Flight.**

When taking off in single-file, the trailing craft rejoins formation after the turn on crosswind leg (or in straight flight after climbing at least 150 m). The crosswind leg turn must be done at an altitude of at least 150 m.

The trailing craft must maintain line of sight on the leading craft in such a way that the stabilizers and the tail end of the other aircraft are viewed on the same plane.

While holding formation, the trailing craft must take into account the inertia of the aircraft: when catching up to the lead craft, the trailing craft must reduce its engine speed in advance, in order to avoid overshooting.

Avoid pitching up unnecessarily as this causes you to bleed speed. Radio communications must be maintained between both craft at all times while in flight.

Aerobatic Maneuvers While in Formation

Diving and zooming while in formation

Procedure:

1. Entry into the dive as a pair is performed in the same way as a turn, at a dive angle of 30 - 90 ° and a roll of up to 45 ° or in a straight line.
2. When diving or zooming, the interval and distance should be 25 - 30 m by 60 - 70 m, a vertical separation of 5 - 7 m, and a zoom or dive angle of 20 °. Zoom departure is performed by turning towards the lead craft or by departing in a straight line.
3. During dive entry from a turn, it should begin in the horizontal plane. Dive angle is then increased to the required value. Before entering, set a vertical separation of 5 - 7 m relative to the lead craft.

4. Maintain correct distance during the dive by manipulating engine supercharging; maintain correct interval with the smooth rudder input.
5. Depart from the dive or zoom at an indicated speed of 300 km/h, basing your heading on the lead craft and keeping a vertical separation of 5 - 7 m.
6. When turning out from the zoom, create roll and perform a turn after receiving the command from the lead craft, taking care to maintain the given interval and distance. This should be performed in such a way that on return to level flight both aircraft will be at the same altitude. During both maneuvers, the trailing craft must take care to maintain the given distance, interval, and vertical separation. They must avoid creating excess roll relative to the lead craft, and closely monitor engine temperature.

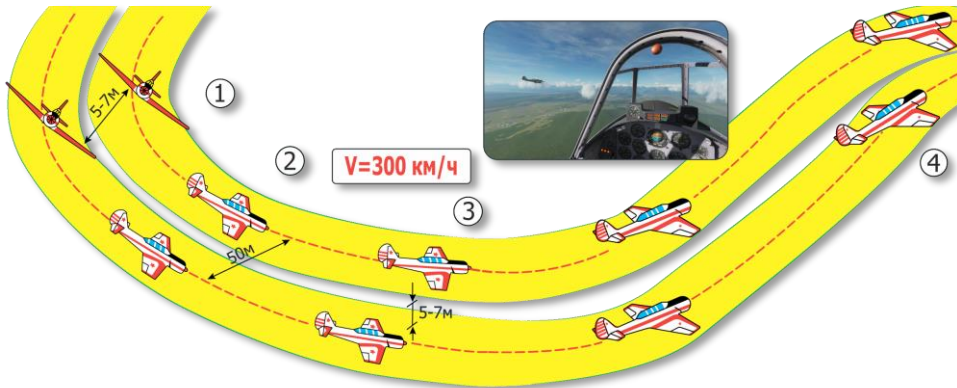

Figure 73. Diving while in formation.

Entry into banking

Begin entry into the turn on receiving the command from the lead craft. As the trailing aircraft, slightly increase engine RPM while simultaneously pulling back on the stick and in the direction of the turn. Take position above the lead craft.

In the process of entering the turn, carefully monitor the changes in the spatial position of the lead craft, and keep the interval, distance and altitude separation.

Being the trailing craft, when entering the turn, slightly reduce engine RPM. Maneuver into the required position by pushing down on the stick and in the direction of the turn.

Banking execution

During the bank, maintain the correct distance changing the engine RPM. The interval is maintained with small movements of the pedals, and also by rolling. The vertical separation is maintained by

coordinated deflections of the elevator and ailerons. Attention should be paid to all three variables while keeping the lead craft in line of sight.

Rollout from banking

Begin departure upon receiving the command from the lead craft. As soon as the lead craft begins reducing their roll, the trailing craft, if located on the outer side, must reduce engine RPM and push back on the stick in the direction of the departure in order to maintain formation. If the trailing craft is located in the inner side, they must increase engine RPM and pull back on the stick to maintain formation in such a way that, on departure, they will be at the same altitude as the lead craft.

Turning while in formation

When executing these turns, the lead craft should set an airspeed 180 km/h and inform the trailing craft by rocking the wing, then give the command over radio to execute the turn. After the command is given, 4 - 6 seconds is given to the trailing craft to adjust their RPM as necessary.

The trailing craft should maintain a roll equal to the lead craft's roll. The lead craft is also kept in line of sight as they would be during level flight.

For this purpose the trailing craft must increase or decrease altitude depending on their position (outer and inner positions respectively). Distance is maintained as it would be during level flight by increasing or decreasing the engine RPM, while the interval is maintained by decreasing roll. When the command is given over radio to roll-out from the turn, the trailing craft, being external with respect to the turn, should reduce engine RPM. If they are internal, RPM should be increased.

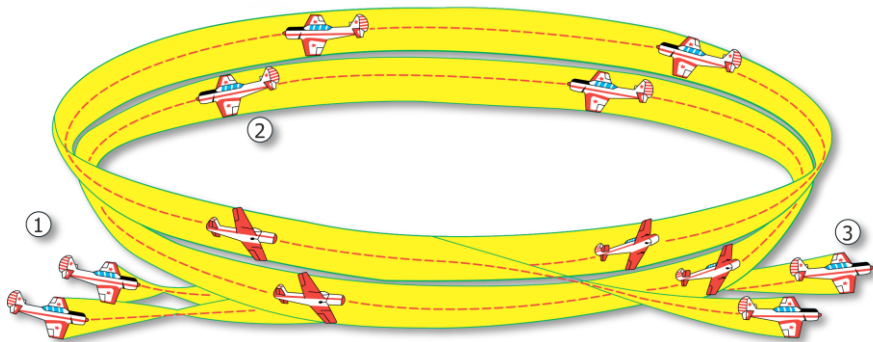

Figure 74. Turning while in formation.

Changing formation

Changing formation should be performed while in horizontal flight. The lead craft gives the command (over radio) or signal (by rocking the wing) to change formation, then increases airspeed to 190 km/h.

After receiving the command, the trailing craft reduces airspeed to 170 km/h and simultaneously descends by 20 - 25 m relative to the lead craft. With the corresponding rudder input, the trailing craft maneuvers into the outboard bearing taking care not to create roll and without losing sight of the lead craft. Having maneuvered to the other side, at an interval of 50 - 75 m, increase or decrease the airspeed in order to set the required distance, and set the required interval with minor rudder inputs in the direction of the lead craft.

Transitioning from the wedge formation to the echelon formation (during wing flight) is done as follows:

- Lead craft gives the command;
- The trailing craft that is to maneuver to the other side acts in the same way as they would when changing formation in pair flight. With a smooth shift towards the lead craft, the wingman moves to the position of the second aircraft in the wing.

Transitioning from echelon to wedge formation is performed in the reverse order.

The lead craft should monitor the actions of the trailing craft and inform them of their errors over radio.

Gliding while in formation

Gliding should be performed at a speed of 170 km/h (at a speed of 160 km/h with the flaps deployed). The lead aircraft gives the command (usually "prepare for glide") over the radio and duplicate this command by means of aircraft movement (by lightly pitching up and down). The trailing craft maneuvers into a glide and maintains an angle with the lead craft as reference, with a vertical separation of 2 - 3 m.

Retracting the undercarriage while in formation

The trailing craft retracts the undercarriage on command from the lead craft. Once the command is given (usually "retract undercarriage"), the trailing craft simultaneously retracts the undercarriage, then trails the lead craft without closing the distance. If, during undercarriage retraction, the trailing craft begins to lag behind, the lead craft informs the trailing craft of this and gives the command to close the distance back to the required value. Both craft should monitor the undercarriage status of the other.

Deploying the undercarriage while in formation

The undercarriage is deployed while in level flight before breaking formation or before performing a pair landing. The flight leader gives the command to break formation and deploy the undercarriage, duplicating the command by pushing the rudder from side to side. It is advisable to increase the interval and distance to 100 m and deploy the undercarriage before the lead craft. During undercarriage release, monitor the lead craft and do not close the distance. The lead craft deploys their undercarriage 2 - 4 seconds after the trailing craft. When the undercarriage is deployed and the lead craft confirms successful deployment (the trailing craft does the same for the lead craft), the lead craft gives the command to close formation to 25 - 30 x 60 - 70 m when breaking formation and landing single-file and 30x30 m when landing as a pair.

Pre-landing formation breakup

The lead craft must reform formation while in level flight between the first (crosswind leg) and fourth (final) turns. Formation is broken during circular flight after passing over the landing signs for the first turn and is broken in such a way that the trailing craft will have enough time to set the necessary distance for landing.

To break formation for landing, the lead craft requests landing permission from flight control and, after obtaining permission, gives the landing command over radio (adding the callsigns of the trailing craft), duplicating the command by moving the aircraft (with a small drop and an exit forward).

Before breaking formation and after the command is given, the trailing craft increase engine RPM and leaves in the direction of the circle at an angle of 90 ° to the direction of the formation flight.

Pair landing

During pair landing, the third and fourth turns, maintenance of the required interval and distance (30x30 m), and the deployment of the landing flaps are all performed by the trailing craft at the command of the lead craft, which should strictly maintain the glide and landing speeds. The lead craft estimates the landing between the "T" and the front boundary, ensuring the successful precision landing of the trailing craft. Turn-off from the strip is permitted only after both aircraft come to a complete stop.

Typical Deviations in Formation Flight

1. Inconsistent interval, altitude, and distance as a result of disproportionate rudder movements and improper RPM management.
 - A precise interval cannot be set with excessive (either in degree or duration) pedal inputs. Thus, in order to avoid creating large deviations in the interval, the inputs must be minor.
 - Disproportionate longitudinal movements of the control stick makes it difficult to maintain the same altitude with the lead craft. Stick input should be short and proportionate.
 - Improper RPM management makes it difficult to maintain the set distance.

The movements of the engine control levers must be smooth and minor.

2. The interval and distance increase as a result of delayed turn entry and departure.
 - When distance and interval at the turn entry increase, the trailing craft should smoothly increase roll and engine RPM to return to the set interval and distance.
 - When distance and interval increase during the turn proper, the trailing craft should reduce roll and increase the engine RPM to catch up with the lead craft.
3. The trailing craft may fly into the backwash of the lead craft due to low vertical separation during formation change.

Before moving to the other side of the lead craft, make sure that the vertical separation is at least 20 - 25 m.

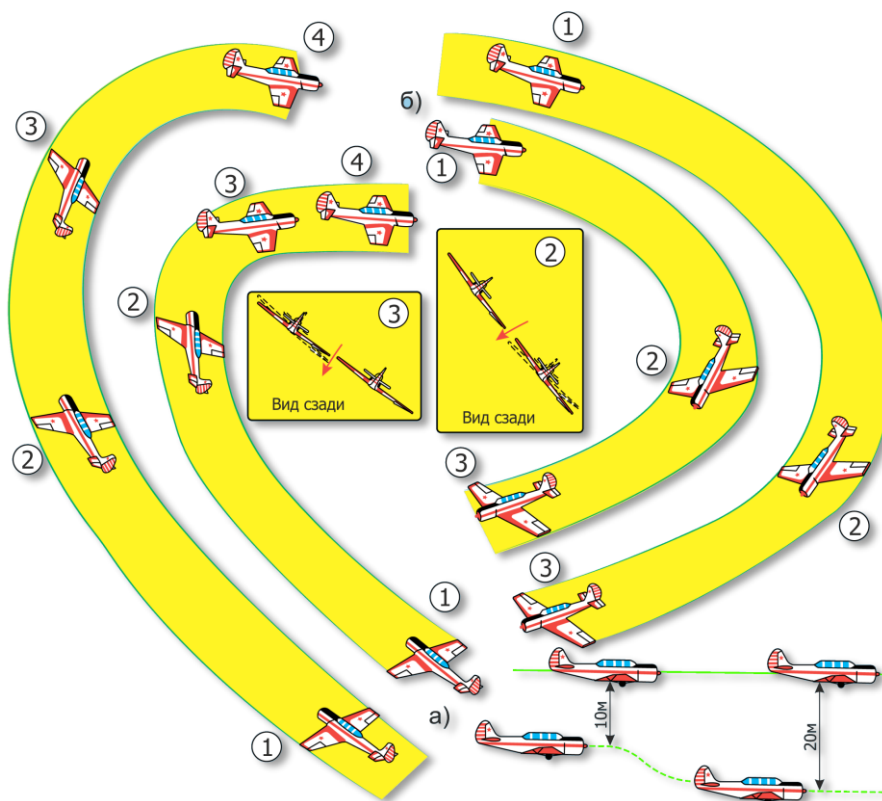

Figure 75. Typical errors during formation flight.

Typical errors during pair takeoff

- After liftoff the trailing craft maneuvers into a climb before the lead craft - low speed of ground separation, visual of the lead craft is lost.
- Lead craft begins takeoff at an RPM of less than 83% - distance is reduced and overtaking is possible.
- Overly sharp input on the brakes or rudders - proper heading is made impossible to maintain and the interval either increases or decreases.

Typical errors when joining formation

- Trailing craft is late to begin takeoff - distance increases.
- Trailing craft fails to account for aircraft inertia, is late to reduce the engine crankshaft speed, or fails to maintain trailing speed - trailing craft overtakes the lead craft.
- Trailing craft joins formation with roll or at an angle to the lead craft - interval quickly reduces.

Typical errors during formation change

- Trailing craft unnecessarily reduces engine crankshaft speed or is late to increase it during the position shift - distance and formation change time increase.
- Too little vertical separation at the beginning of the maneuver - trailing craft may potentially fly into the lead craft's backwash.
- Untimely decrease in crankshaft speed when the distance is reduced after formation change - trailing craft may potentially overtake the lead craft.

Typical errors during formation diving

- Trailing craft has high engine crankshaft speed on entry - trailing craft may potentially overtake the lead craft
- Trailing craft fails to notice their roll or involuntarily deflects the stick - interval may increase or decrease.
- Vertical separation is too low when entering the dive - visual of the lead craft may be lost.

Typical errors during formation zoom

- Trailing craft lags behind or increases vertical separation - zoom departure is made more difficult, visual of the lead craft may be lost.
- Energetic entry into the zoom - trailing craft lags behind, increase in distance between the two aircraft.
- Trailing craft fails to notice an increase in roll or involuntarily deflects the stick during the zoom - interval increases or decreases.

Typical errors during pair landing

- Trailing craft located above the lead craft during the final turn - after departing from the turn and maneuvering into the glide the trailing craft may overtake the lead craft.
- Lead craft begins gliding at a low engine RPM - the trailing craft will have difficulty in maintaining the distance and may overtake the lead craft during gliding.
- Trailing craft located above the lead craft before flaring - lead craft touches down first, trailing craft may overtake during the ground roll.

Pilot actions after losing visual of the lead craft

If the trailing craft loses sight of the lead craft during the banking turn, they must immediately roll out of the turn and report the situation to the lead craft, informing them of trailing craft's altitude and flight heading. The trailing craft looks around and returns to formation only after contact is re-established.

ADDITIONAL INFORMATION



RADIO COMMUNICATIONS

Two modes of conducting radio communication are present in the simulator:

- Simplified
- Realistic

The player may select one of these modes in the settings menu of the game by checking or unchecking the box for «Easy Communication» under the GAMEPLAY tab. If this option is disabled, in-game radio communication will be set to realistic by default. The selected mode also determines the keybindings used to bring down the radio menu.

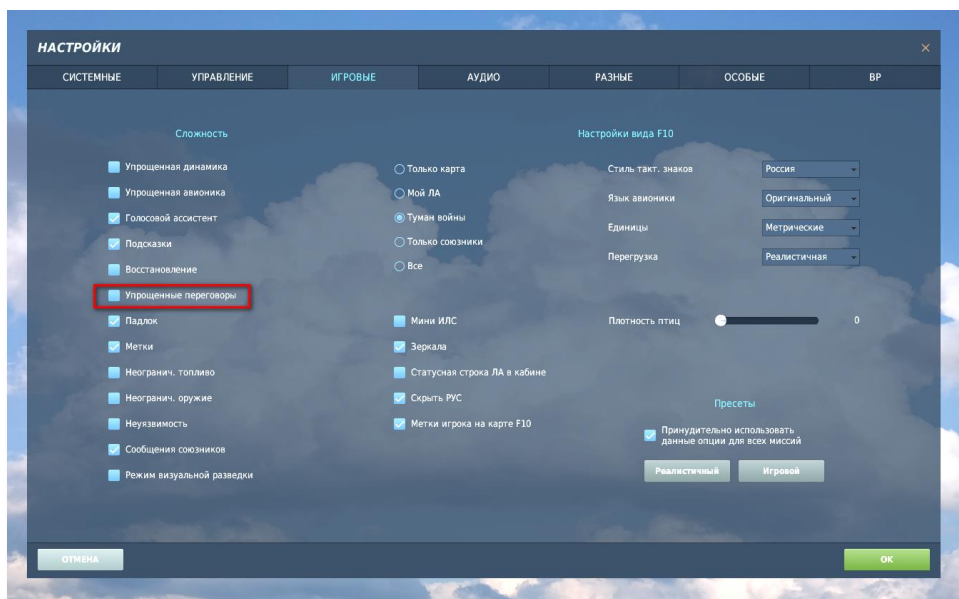

Figure 76. Enabling **SIMPLIFIED COMMUNICATIONS** in the **GAMEPLAY** tab, in the settings menu

All available radio commands and messages are transmitted and received through the onboard radio station, which must be set to a common frequency for it to work. If this requirement is not met, then the intended recipient will not be able to receive the transmission.



In real life, VHF radio communication is stable only within line of sight. The simulator also has built-in algorithms for calculating distance and the radio shadowing caused by the terrain horizon. A necessary condition for the transmission of messages or commands is line of sight to the recipient as well as a distance of not more than 100 - 150 km. In such cases where the recipient is located beyond this distance, or line of sight is obscured by terrain, the message will not be received.

You can perform radio communication only with recipients whose radio stations are tuned to your frequencies. Frequencies of the radio channels of the Landysh-5 radio station are set on the control panel of the radio station.

Simplified Radio Communication

The radio communications window is accessed by a press of the **[N]** key. After the command selection the radio or interphone will be selected (if required) and tuned (if required) automatically. The **[N]** key will close radio command menu, if open.

When the radio menu is displayed, recipients are color-coded as follows:

- Recipients on which at least one of the radios is tuned to are colored white.
- Recipients on which at least one of the radios can be tuned to but is not currently on the correct frequency are colored gray.
- Recipients that cannot be contacted due to range or terrain masking / earth curvature are colored black.

Each will also have their modulation / frequency listed. When you select a recipient, the appropriate radio will automatically be tuned to communicate with the selected recipient.

When Easy Communications mode is enabled, the following 'quick' command shortcuts are also available:

[LWIN + U] Request AWACS vector to home plate.

[LWIN + G] Command flight to attack ground targets.

[LWIN + D] Command flight to attack air defense targets.

[LWIN + W] Command flight to cover me.

[LWIN + E] Command flight to proceed with the mission and return to base.

[LWIN + R] Command flight to proceed with the mission and rejoin.

[LWIN + T] Command flight to open/close the formation.

[LWIN + Y] Command flight to rejoin the formation.

Realistic Radio Communication

When playing with realistic radio comms enabled, access to the radio menu is done by pushing [RAIt - \].

When recipients are displayed, there is no color-coding of availability and no listing of their modulation / frequency. This is the more realistic play mode and requires you to know the correct modulation / frequencies for each recipient and you must manually enter the frequencies on the correct radio.

Radiocommunications Menu

Top level recipient list:

If using "Easy Communications", recipients not present in the mission will not be listed.

F1. Wingman...

F2. Flight...

F3. Second Element...

F5. ATCs...

F8. Ground Crew...

F10. Other...

F12. Exit

Hotkeys will also be available to directly issue any command in the structure. These can be found in Input Options.

To exit radio communications, you can also press the ESC key.

F1 Wingman

Upon selecting [F1] Wingman from the main radio communications window, you have the option to select the basic type of message you wish to send to your number 2 wingman. These are:

F1. Navigation...

F4. Maneuvers...**F5. Rejoin Formation****F11. Previous Menu****F12. Exit****F1 Navigation...**

The Navigation options allow you to direct where your wingman will fly to.

F1. Anchor Here. Your wingman will orbit at its current location until you issue a Rejoin command.

F2. Return to base. Your wingman will return to and land at the airbase designated in the flight plan.

F11. Previous Menu**F12. Exit****F4 Maneuver...**

Although your wingman will generally do a good job of knowing when and how to maneuver, there may be times when you want to give him/her a very specific maneuvering order.

F1. Break Right. This command will order your wingman to make a maximum-G break to the right.

F2. Break Left. This command will order your wingman to make a maximum-G break to the left.

F3. Break High. This command will order your wingman to make a maximum-G break high.

F4. Break Low. This command will order your wingman to make a maximum-G break low.

F7. Clear Right. Your wingman will perform a 360-degree turn to the right of the current flight path while searching for targets.

F8. Clear Left. Your wingman will perform a 360-degree turn to the left of the current flight path while searching for targets.

F9. Pump. Your wingman will perform a 180-degree turn from its current heading and fly 18km. Once reached, it will turn 180-degrees back to the original heading.

F5 Rejoin Formation

Issuing this command will instruct your wingman to cease its current task and rejoin formation with you.

F2 Flight

Upon selecting [F2] Flight from the main radio communications window, you have the option to select the basic type of message you wish to send. These are:

F1. Navigation...

F4. Maneuvers...

F5. Formation

F6. Rejoin Formation

F11. Previous Menu

F12. Exit

F1 Navigation...

The options in the "Navigation" submenu allow you to give orders related to changes in the wing's flight path.

F1 Anchor Here

F2 Return to base

F11 Previous Menu

F12 Exit

These commands mirror those of the Wingman Navigation commands, but apply to all flight members.

F4 Maneuvers...

These commands mirror those of the Wingman Maneuvers commands, but apply to all flight members.

F1 Break Right

F2 Break Left

F3 Break High

F4 Break Low

F7 Clear Right

F8 Clear Left

F9 Pump

F11 Previous Menu

F5 Formation

From the Formation menu, you can select the formation that the flight will fly in relation to you as the flight leader.

F1 Go Line Abreast

F2 Go Trail

F3 Go Wedge

F4 Go Echelon Right

F5 Go Echelon Left

F6 Go Finger Four

F7 Go Spread Four

F8 Open Formation. Increases the distance between each aircraft within the current formation.

F9 Close Formation. Decreases the distance between each aircraft within the current formation.

F11 Previous Menu

F12 Exit

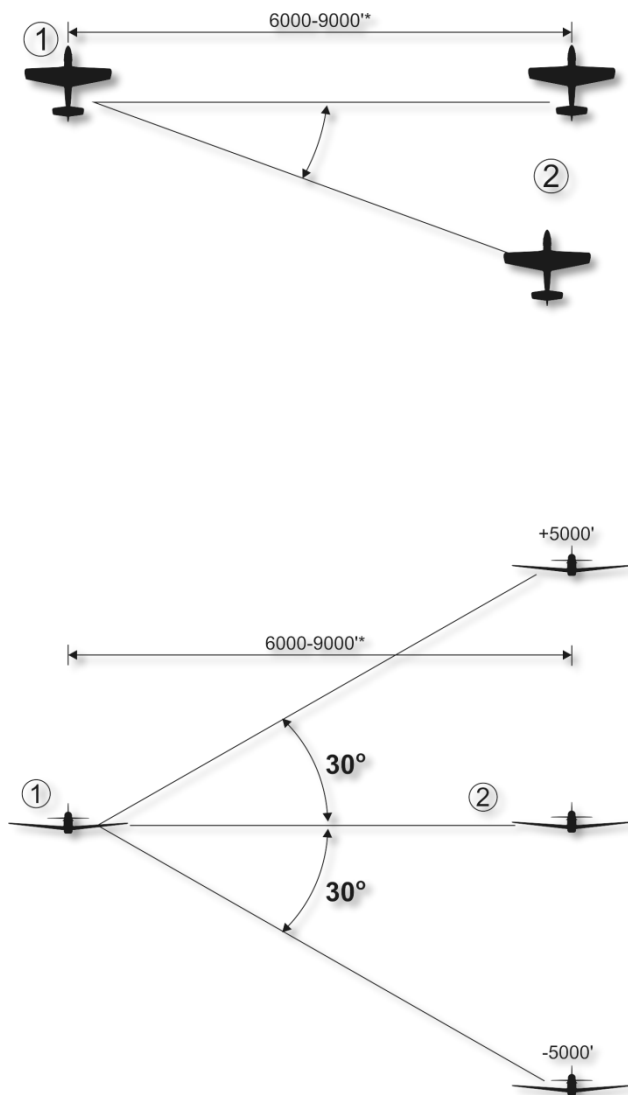

Figure 77. **Line abreast formation.**

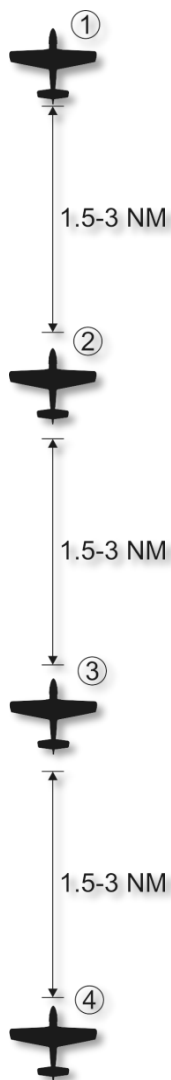

Figure 78. **Trail formation.**

Position may be modified within a 1500 - 4000m envelope by flight lead.

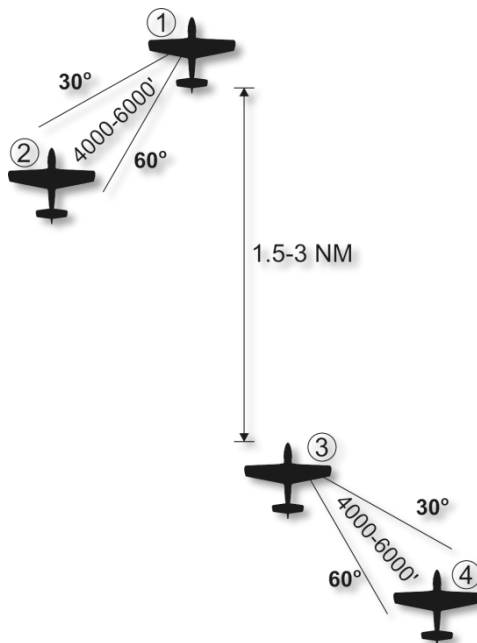

Figure 79. **Wedge formation.**

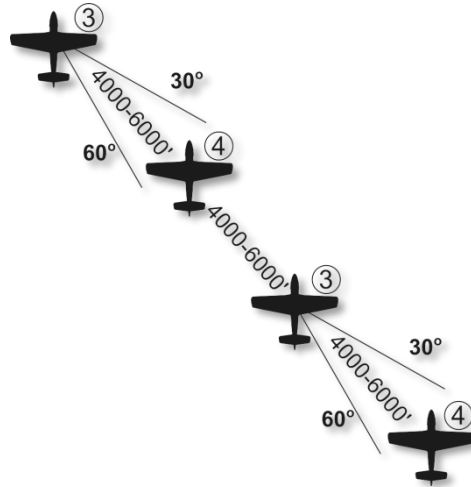

Figure 80. Right echelon formation.

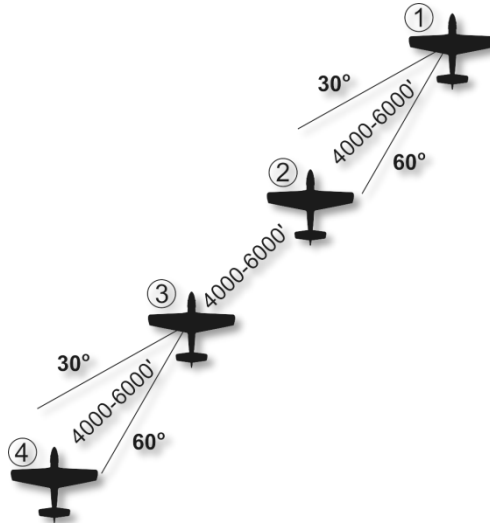

Figure 81. Left echelon formation.

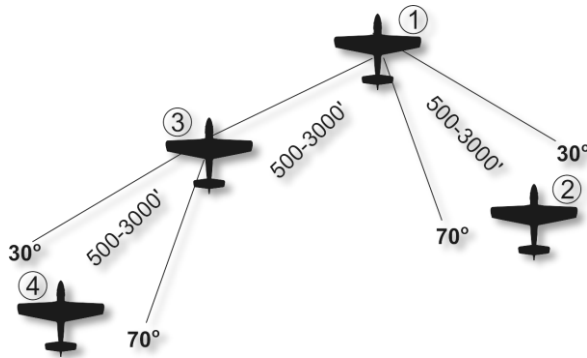

Figure 82. **Finger four formation.**

Position may be modified within a 1500 - 4000m envelope by flight lead.



Figure 83. **Spread four formation.**

Position may be modified within a 1500 - 4000m envelope by flight lead.

F6 Rejoin Formation

Issuing this command will instruct your flight to cease their current task and rejoin formation with you.

F3 Second Element

Upon selecting F3 Second Element from the main radio communications window, you must select the basic type of message you wish to send to the second element of your flight. The second element consists of flight members 3 and 4 with number 3 being the element lead. When issuing a command to Second Element, number 3 and 4 will simultaneously carry out the order. These commands are:

F1 Navigation...

F4 Maneuvers...**F5 Rejoin Formation****F11 Previous Menu****F12 Exit****F1 Navigation...**

The options in the "Navigation" submenu allow you to give orders related to changes in the second element's flight path.

F1 Anchor Here**F2 Return to base****F11 Previous Menu****F12 Exit**

These commands mirror those of the Wingman Navigation commands, but apply to your Second Element aircraft.

F4 Maneuvers...

Although your second element will generally do a good job of knowing when and how to maneuver, there may be times when you want to give them a very specific maneuvering order. This could be in response to a threat like an incoming SAM, or to better set up an attack.

F1 Break Right**F2 Break Left****F3 Break High****F4 Break Low****F7 Clear Right****F8 Clear Left****F9 Pump****F11 Previous Menu**

These commands mirror those of the Wingman Maneuvers commands, but apply to your Second Element aircraft.

F5 Rejoin Formation

Issuing this command will instruct your second element to cease its current task and rejoin formation with you.

Flight Member Responses

After sending a radio message to any of your flight members, you will have one of two responses:

Flight number of responder (2, 3, or 4), acknowledged. When a flight member is able to carry out the order, it will respond with its flight number and add "acknowledged."

(Flight member number) unable. When a flight member cannot carry out the order, it will respond with its flight number, followed by "unable". For example: "2, unable"

F5 Air Traffic Controller (ATC)

This group of radio commands relating to communication and simultaneous action with the Air Traffic Controller (ATC) includes a menu for requests for permission for engine startup, taxiing, takeoff and return to base.

The menu is called down by using the following keypresses:

[V] Commands → [F5] ATC...

The Air Traffic Control (ATC) system of this simulation is context sensitive to the location of your aircraft: on the parking ramp or runway/airborne. A necessary condition for the functioning of the ATC is the presence of certain surface facilities that are associated with it. For example, in order to transmit a response to player requests, the airfield control tower must be undamaged.

To conduct two-way radio communication between player and recipient, the frequency at which the recipient's radio station is transmitting must match the frequency of the selected channel of the player's radio station. The radio channels of aviation radio stations are set in the mission editor and should be available in the briefing.

The control tower of each airfield has several radio stations operating in different frequency bands for communication with aircraft of various classes. The ATC radio frequencies for each airfield can be viewed in the mission editor or on the map ([F10]) by selecting the airfield of interest.

Parking Ramp Start

Prior to engine startup the pilot must request the corresponding clearance from the ATC. For this, the player must ensure that the radiostation is switched on and operational, after which the player presses [V] or [RAIt - V] to bring up the radiocommunications menu. Press [F1] to request startup clearance.

If you have wingmen, they will also now start their engine.

After the aircraft has been started and configured, select [F1] "Request taxi to runway". Once you receive permission, you can taxi to the "hold short" area of the taxiway - the area on the taxiway just short of entering the runway.

If you have wingmen, they will also now taxi to the runway.

When at the hold short area, press [V] or [RAIt - V] and then [F1] "Request takeoff". When permission is granted, you can taxi on to the runway and takeoff.

Air Start and Landing

If you are not starting from the parking ramp, you can access ATC by pressing the [\\] or [RAlt - \\] keys. Then, press [F5] for the ATC.

If you are using "Easy Communications", a list of airfield ATCs will be shown along with their contact frequencies. Select the airfield ATC you wish to contact. If not using Easy Communications, you will first need to manually set the frequency used by the desired airfield.

Once the airfield ATC is selected, you can either send them an "Inbound" message to indicate that you intend to land there.

The ATC will respond by providing you the following information:

- Heading to fly to reach landing initial point.
- Range to landing initial point.
- The QFE, or atmospheric pressure at the airfield elevation.
- Which runway to land on.

Upon approach to the descent starting point (from the 5KM border), the ATC will transmit "(callsign,) you are cleared to land." After this message, the pilot must respond with "Request Landing."

If the pilot does not intend to land at the airfield, they must respond with "Abort landing."

If the runway is clear, the ATC then gives permission and reports the runway heading as well as the direction and speed of wind near the earth. If the runway is occupied, the ATC will prohibit the landing and give instructions for a go-around..

"Request Azimuth" sends the ATC a request for navigational assistance.

"Request Azimuth" transmits to the automatic airfield directional radio in case of a loss of orientation while in flight.

In reality, "Request Azimuth" is served in case of a loss of orientation in flight upon failure of the aircraft's navigation equipment, or while flying in adverse weather conditions or at night. This request is received by the automatic direction finder (ADF) at the airport, after which the operator of the ARP transmits a direct course to the airport.

In-game, in case of loss of orientation, a player may "request azimuth", which will be answered with a direct course to the nearest airfield. Approach the airport by flying this heading.

If you choose to land and are on the glide path, make a second request for landing permission. If the runway is free, the control tower will give permission and inform the pilot on the direction and speed of wind.

After landing, taxi to the parking area and shut down the aircraft.

F8 Ground Crews

After landing at a friendly airfield and taxiing to a parking ramp, you can communicate with the ground crew for rearming and refueling by pressing the [F8] button to display the Ground Crew menu.

The command list for ground personnel includes the menu for editing the aircraft loadout and fuel load, as well as for selecting the aircraft power source.

- [F1] Request for refuel and rearm.
- [F2] Request for aircraft connection to airfield power source.
- [F3] Request for repairs.
- [F4] Brake chokes.

ADDENDUM

Caucasus Airfield Data, With SHORAN

Airfields	Artificial Airfield Location	SHORAN channels		ATC Frequency MHz	Outer NDB Frequency KHz	Inner NDB Frequency KHz
		H	П			
URKI Krasnodar Tsentralniy «Volokno» (Russia)	09-27° Runway=2500x40 m	40	38 (09°)	251.0/122.0/ 38.60/3.80	625	303
URKH Maykop «Khanskaya » (Russia)	04-22° Runway=3200x40 m	34	36 (04°)	254.0/125.0/ 39.20/3.95	288	591
URKW Krymsk «Taymyr» (Russia)	04-22° Runway=2600x40 m	28	26	253.0/124.0/ 39.0/3.90	408	803
XRMF Mozdok «Raspiska» (Russia)	08-27° Runway=3100x80m	20	22	266.0/137.0/ 41.60/4.55	525	1065

Caucasus Airfield Data

Airfields	Artificial Airfield Location	ATC Frequency MHz	Outer NDB Frequency KHz	Inner NDB Frequency KHz
UG23 Gudauta – Bambara (Abkhazia)	15-33° Runway=2500x40 m	209.00/130.0 40.20/4.20	---	395 (33°)
UG24 Tbilisi – Soganlug (Georgia)	14-32° Runway=2400x40 m	218.0/139.0 42.0/4.65	---	---
UG27 Vaziani (Georgia)	14-32° Runway=2500x40 m	219.0/140.0 42.20/4.70	---	---
UG5X Kobuleti (Georgia)	07-25° Runway=2400x40 m	212.0/133.0 40.80/4.35	870	490
UGKO Kutaisi - Kopitnari (Georgia)	08-26° Runway=2500x40 m	213.0/134.0 41.0/4.40	---	477 (08°)
UGKS Senaki - Kolkhi (Georgia)	09-27° Runway=2400x40 m	211.0/132.0 40.60/4.30	335	688
UGSB Batumi (Georgia)	13-31° Runway=2400x40 m	210.0/131.0 40.40/4.25	---	430 (31°)
UGSS Sukhumi - Babushara (Abkhazia)	12-30° Runway=2500x40 m	208.0/129.0 40.0/4.15	489	995
UGTB Tbilisi - Lochini (Georgia)	13-31° Runway=3000x40 m	217.0/138.0 41.80/4.60	342 (13°) 211 (31°)	923 (13°) 435 (31°)
URKA Anapa - Vityazevo (Russia)	04-22° Runway=2900x40 m	200.0/121.0 38.40/3.75	443	215
URKG Gelenzhik (Russia)	04-22° Runway=1800x40 m	205.0/126.0 39.40/4.00	---	1000
URKK Krasnodar - Pashkovskiy (Russia)	05-23° Runway=3100x40 m	207.0/128.0 39.80/4.10	493	240

URKN Novorossiysk (Russia)	04-22° Runway=1780x40 m	202.0/123.0 38.80/3.85	---	---
URMM Mineralnye Vody (Russia)	12-30° Runway=3900x40 m	214.0/135.0 41.20/4.45	583	283
URMN Nalchik (Russia)	06-24° Runway=2300x40 m	215.0/136.0 41.40/4.50	718 (24°)	350 (24°)
URMO Beslan (Russia)	10-28° Runway=3000x40 m	220.0/141.0 42.40/4.75	1050(10°)	250 (10°)
URSS Sochi - Adler (Russia)	06-24° Runway=3100x40 m	206.0/127.0 39.60/4.05	---	761 (06°)

Nevada Airfield Data

Airfields	Artificial Airfield Location	TACAN Channel	ILS Frequency	ATC Frequency MHz
KXTA Groom Lake AFB (USA)	14L-32R 3500 m	18X (GRL)	32 ILS - 109.30 (GLRI)	252.0/123.0/38.8
KINS Creech AFB (USA)	13-31 1500 m, 08-27 2700 m	87X (INS)	13 ILS - 108.5 (ICRS)	251.0/122.0/38.6
KLSV Nellis AFB (USA)	03L-21R 3000 m, 03R-21L 3000 m	12X (LSV)		254.0/125.0/39.2
KLAS Mc Carran International (USA)	07K-25Д 3100 m 07Д-25K 3300 m 01K-19Д 2500 m 01Д-19K 2500 m	116X (LAS)	25 ILS - 111.75 (IRLE)	253.0/124.0/39.0

Eagle Dynamics

Executive Board

Nick Grey

Igor Tishin

Katarina Perederko

Sergei Gerasev

Andrei Chizh

Matt «Wags» Wagner

Matthias «Groove» Techmanski

Project Head, Director of The Fighter Collection

Director of Eagle Dynamics (Russia)

Director of Eagle Dynamics (Russia)

Project Manager

Development Assistant & QA Manager, Producer, Technical Documentation

Producer, Game and Technical Documentation, Game Design

Localization Manager

Programmers

Alexander Oykin

Roman «Made Dragon» Deniskin

Dmitry «Yo-Yo» Moskalenko

Maksim Zelensky

Dmitry Baikov

Senior Programmer

Aircraft Settings, Aircraft Systems and Flight Models

Mathematical Models: Dynamics, Systems, and Ballistics

Aircraft, Aircraft AI, Flight and Damage Models

Systems, Multiplayer, Sound Engine

Designers

Pavel «DGambo» Sidorov

Yevgeniy «GK» Khizhnyak

Alexander «Skylark» Drannikov

Lead Designer

Aircraft, Vehicles

GUI, Graphics, Aircraft

Sound

Konstantin «btd» Kuznetsov

Sound director, composer

Quality Control

Valery «USSR_Rik» Khomenok Lead tester

Alexander «BillyCrusher» Biliyevsky Tester

Localization

Jzan Lo Pilot's Manual English translation

IT and Customer Support

Konstantin «Const» Borovik Systems and Network Administrator, Web and Forums

Andrey Filin Systems and Network Administrator, Customer Support

Konstantin «MotorEAST» Kharin Customer Support

Special thanks to all participants of the Yak-52 beta test!

EAGLE DYNAMICS ©
2018